

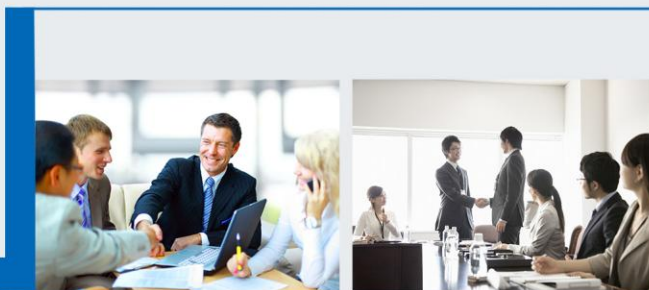

Htek IP Phones UC926E User Manual



Version 2.0.4.4.29
Mar. 2018

Notices Information

Copyright

Copyright © 2005 - 2018 Nanjing Hanlong Technology CO., LTD. All rights reserved.

Nanjing Hanlong Technology Co., LTD. owns all the rights to modify and copy this document at any time. And all the illustrations and text in this document are copyright protected. Therefore, no parts of this document may be used or reproduced, transmitted by the third parties for any purposes without the express written permission of Nanjing Hanlong Technology CO., LTD.

When this document is made available on www.htek.com, Nanjing Hanlong Technology Co., LTD. gives its right to download and print copies of this content only for private use as a user manual. No parts shall have the right to alter, modify or use as commercial means without prior written permission from Nanjing Hanlong Technology Co., LTD.

Safety Instructions

- To use the Phone, please follow the instructions in this user manual.
- Use the power adapter supplied with your phone. Other power adapters may damage the phone.
- This phone is only for indoor use. And also avoid in high humidity, water and some other liquids.
- Do not use the phone during thunderstorms.
- CE
- FCC

WEEE Warning



To avoid the potential effects on the environment and human health as a result of the presence of hazardous substances in electrical and electronic equipment, end users of electrical and electronic equipment should understand the meaning of the crossed-out wheeled bin symbol. Do not dispose of WEEE as unsorted municipal waste and have to collect such WEEE separately.

Cleaning

To clean the device, use an anti-static cloth. Please avoid cleaning liquids as they might

damage the surface or internal electronics of the phone.

FCC Statement

1. This device complies with Part 15 of the FCC Rules. Operation is subject to the following two conditions:

- (1) This device may not cause harmful interference.
- (2) This device must accept any interference received, including interference that may cause undesired operation.

2. Changes or modifications not expressly approved by the party responsible for compliance could void the user's authority to operate the equipment.

NOTE: This equipment has been tested and found to comply with the limits for a Class B digital device, pursuant to Part 15 of the FCC Rules. These limits are designed to provide reasonable protection against harmful interference in a residential installation.

This equipment generates uses and can radiate radio frequency energy and, if not installed and used in accordance with the instructions, may cause harmful interference to radio communications. However, there is no guarantee that interference will not occur in a particular installation. If this equipment does cause harmful interference to radio or television reception, which can be determined by turning the equipment off and on, the user is encouraged to try to correct the interference by one or more of the following measures:

- Reorient or relocate the receiving antenna.

- Increase the separation between the equipment and receiver.

- Connect the equipment into an outlet on a circuit different from that to which the receiver is connected.

- Consult the dealer or an experienced radio/TV technician for help.

*RF warning for Mobile device:

This equipment complies with FCC radiation exposure limits set forth for an uncontrolled environment. This equipment should be installed and operated with minimum distance 20cm between the radiator & your body.

Summary of changes

This section describes the changes to this user manual for each release and user manual version.

Change for Release x.0.4.4.27, Manual version x.0.4.4.27

Major updates have occurred to the following sections:

- UC926E supports 16 accounts

Change for Release x.0.4.4.12, Manual version x.0.4.4.12

Major updates have occurred to the following sections:

- [BT Feature](#)
- [Wi-Fi Feature](#)

Table of Content

Notices Information	2
Copyright	2
Safety Instructions	2
WEEE Warning	2
Cleaning	2
FCC Statement	3
Summary of changes	4
Change for Release x.0.4.4.27,Manual version x.0.4.4.27	4
Change for Release x.0.4.4.12,Manual version x.0.4.4.12	4
Table of Content	5
Getting Started	10
Packing List	10
Phone Installation	12
1. Attach the phone stand	12
2. Connect the Handset and optional Headset	13
3. Connect the Network and Power	13
Initialization Process	14
Status	15
Registration	18
Idle Screen	24
Getting Familiar with Your Phone	25
Hardware Components Preview	25
Icon Preview	28
LED Instruction	31
Power Indicator LED	31
Line LED:(Line Key set as Line)	31
BLF or BLF List Key LED :(Line/Line Key set as BLF)	31
Shared Line LED:	32
Other Key Led	33
User Interface	33
Line Key Function Overview	34
Basic Setting Configuration	37
General Settings	37
Web Login	37
Administrator Password	38
Display Mode	40
Language	40
Wallpaper	42
Screen Saver	43
Backlight	46
Time and Date	47

LED Status Setting-----	54
Key as Send-----	55
Network Setting -----	56
IPv4 -----	56
IPv6-----	60
IPv4&IPv6 -----	62
PC Port-----	63
Contact Setting-----	66
Local Directory-----	66
Remote Phonebook-----	72
LDAP Phonebook -----	72
Search Contact -----	75
Call History Setting -----	76
Call History -----	76
Audio Setting -----	80
Ring Tone-----	80
Volume -----	82
Voice Mail Tone-----	84
Play Hold Tone-----	85
Play Hold Tone Delay-----	85
System Settings-----	85
Dial Plan -----	85
Dial-Now Timeout -----	87
No Key Entry Timeout -----	87
Emergency Call-----	87
Label Scroll-----	88
Show Missed Calls-----	89
Auto Logout Time -----	89
Reboot in Talking-----	89
Detect IP Conflict-----	90
Redial Mode-----	90
Keypad Lock -----	90
Suppress DTMF Display-----	92
Suppress DTMF Display Delay -----	92
Check-Syn With Authenticate -----	92
Other features settings -----	93
Action URL -----	93
Softkey Layout-----	94
Programmable Key -----	95
Exp Key-----	96
Basic Call Features -----	96
Place a Call-----	96
End a Call-----	97
Redial a Call-----	98

Receive a Call-----	98
Incoming Call Show Mode -----	99
Auto Answer -----	100
Call Hold-----	100
Call Transfer-----	102
Call Conference-----	105
Call Forward-----	106
Call Return-----	111
Call Back -----	111
Call Waiting Tone -----	113
Hide Caller ID-----	113
Reject Anonymous-----	114
Call Mute -----	115
DND -----	116
Hot Line-----	116
Auto Redial-----	117
Function Key Features and Settings-----	118
Line-----	119
Speed Dial -----	120
BLF-----	121
Visual Alert for BLF Pickup-----	122
Audio Alert for BLF Pickup -----	123
BLF List-----	123
Voice Message -----	125
Direct Pickup -----	127
Group Pickup-----	128
Call Park-----	129
Intercom -----	130
Intercom Barge-----	131
DTMF -----	132
Prefix-----	133
Local Group-----	134
XML Group-----	135
LDAP-----	136
XML Browser -----	136
Broadsoft Group -----	137
Conference-----	138
Forward-----	139
Transfer-----	139
Hold -----	140
Group Listening -----	141
DND -----	141
Redial -----	142
SMS -----	142

Send SMS	142
Set SMS Line Key	143
Record	144
URL Record	145
Paging	146
Shared Line	146
Public Hold	148
Private Hold	149
Hot Desking	150
ACD	151
Zero Touch	152
Multicast Paging	153
Sending RTP Stream	153
Receiving RTP Stream	154
BT Feature	155
WIFI Feature	164
Manual	164
Provision	172
Upgrade	174
Factory Reset	174
Pcap Feature	174
System Log	175
Upgrade	175
Configuration File	178
Troubleshooting	179
Why is the phone LCD screen blank?	179
When the phone display "Network Unavailable"?	179
When you can't I get a dial tone?	179
Where to set the tone?	179
Why can't the phone detect the Bluetooth headset?	180
Why there is a noise in the Bluetooth headset?	180
Why the Bluetooth headset cannot be off-hook?	180
Why can't the IP phone connect to Wi-Fi?	180
Why is the wireless signal strength low?	181
How to download XML Configuration?	181
How to Import Trusted CA certificate?	181
How to Import Server CA certificate?	181
How to use Vlan?	182
How to use LLDP?	182
How to Set LCD and Web GUI?	182
How to Upgrade via FTP?	182
How to make Ringtone?	183
How to use Open VPN?	183
Provisioning Guide on Free PBX	183

Redundancy Server	183
How to Use Auto Provision Phonebook?	183
All Documents	183

Getting Started

Packing List

The package contains the following parts, please check if all the items are not missed:

1. The phone station

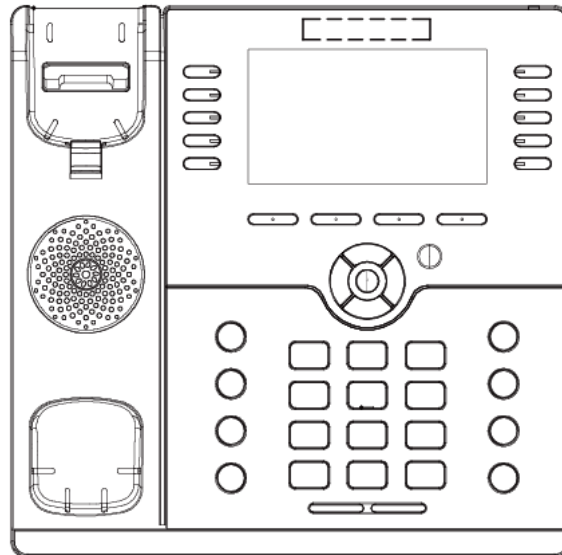

2. The phone stand

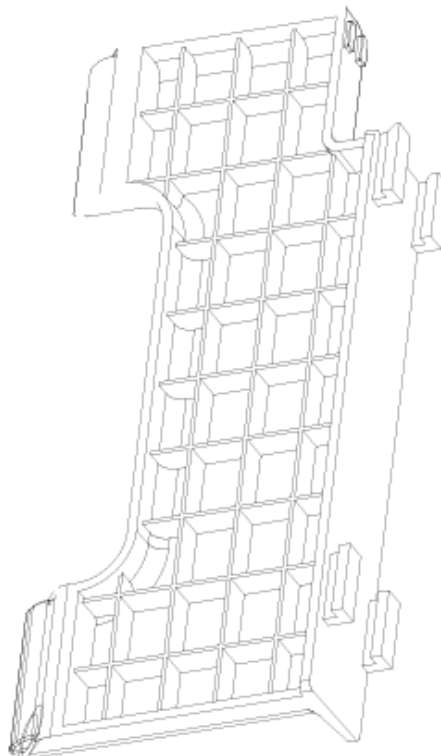

3. Handset



4. Headset cord

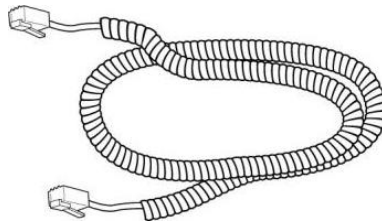

5. Power adapter

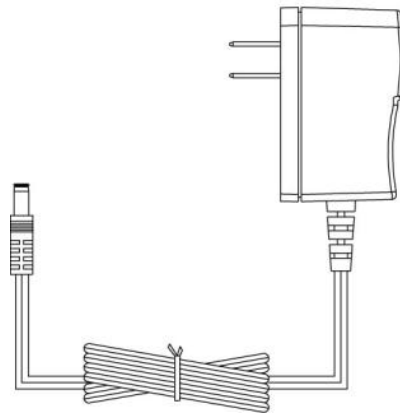

6. Ethernet cable

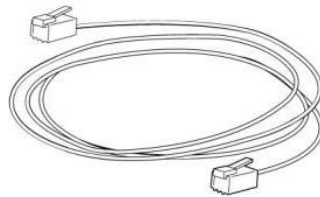

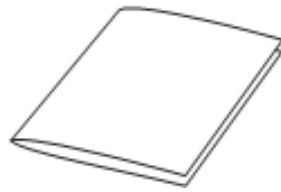

Phone Installation

1. Attach the phone stand

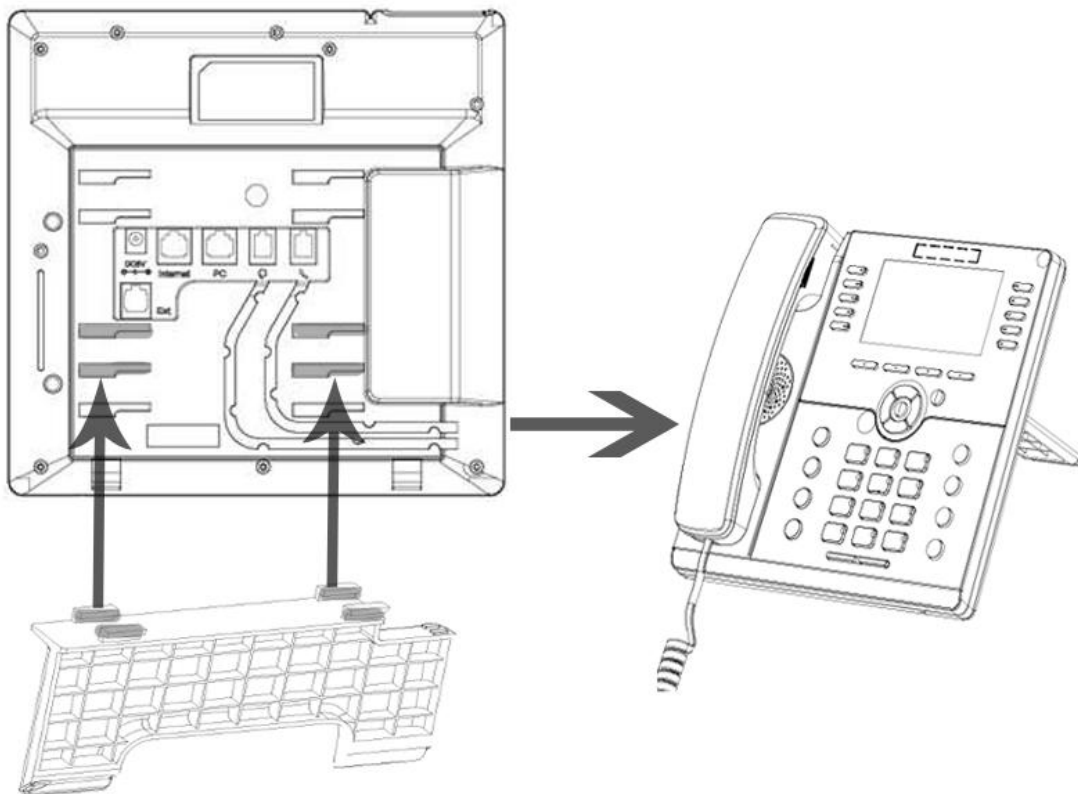

2. Connect the Handset and optional Headset

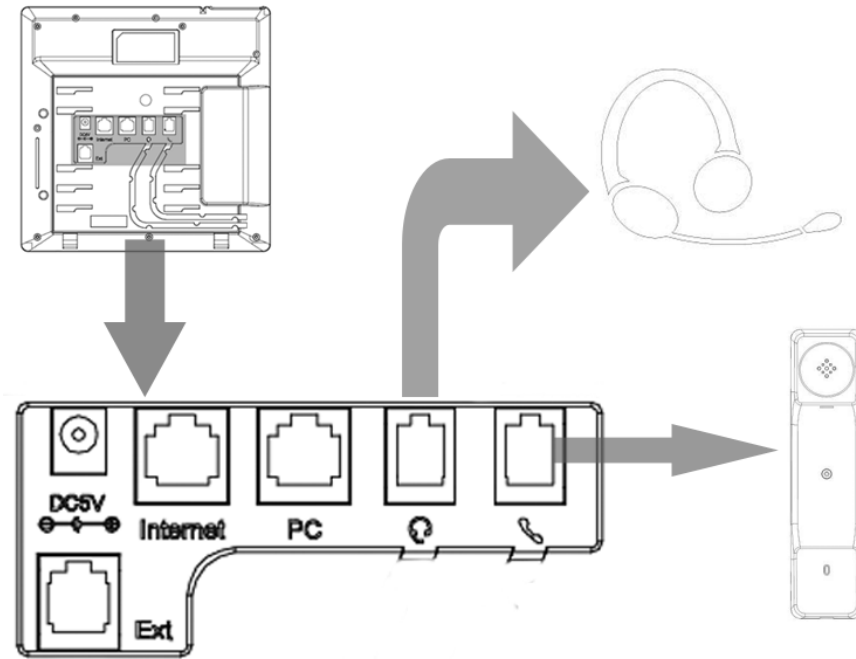

3. Connect the Network and Power

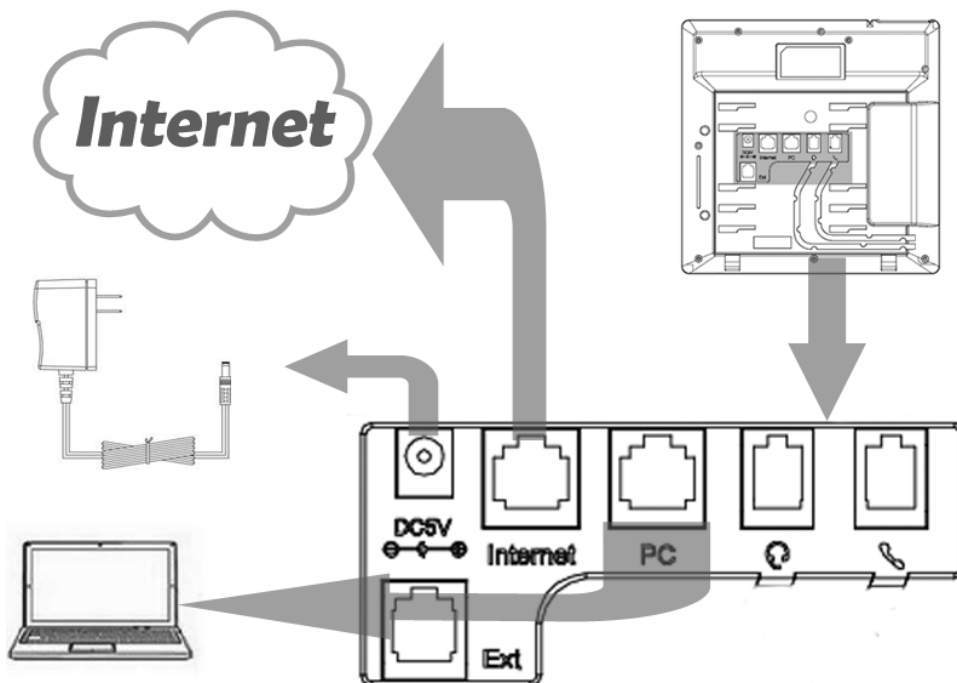

Initialization Process.

After your phone has been powered up, the system boots up and performs the following steps:

Automatic Phone Initialization

The phone finishes the initialization process by loading the saved configuration. The phone LCD screen will display “Booting”



And then show “Initializing” during the initialization.

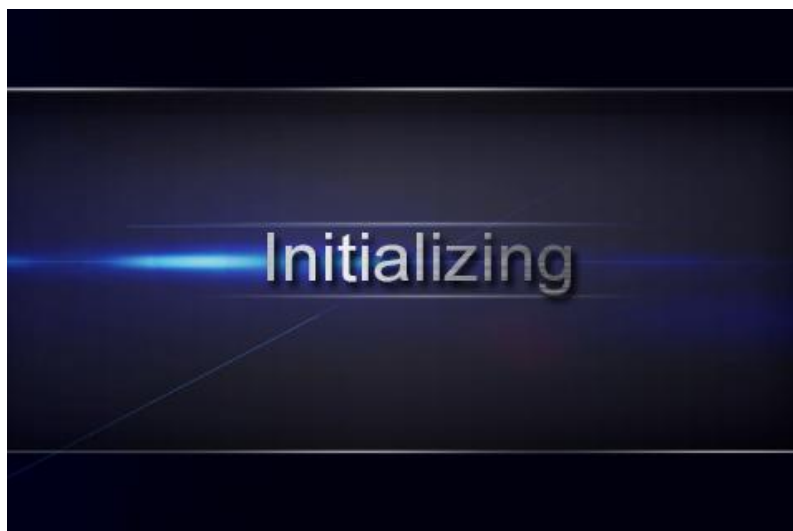

The IP Phone will upgrade the firmware if there is a new firmware on your server. And the IP Phone will show “Check firmware, please wait...” after initialization.

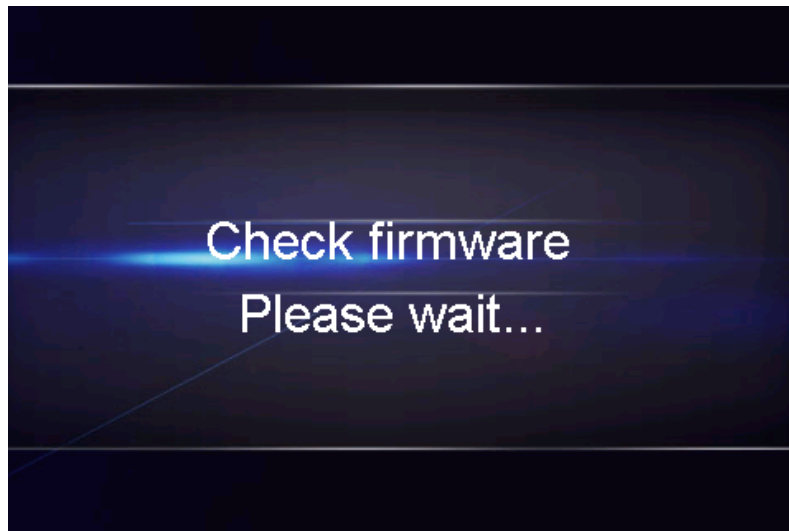

Then IP Phone will show Reboot information:

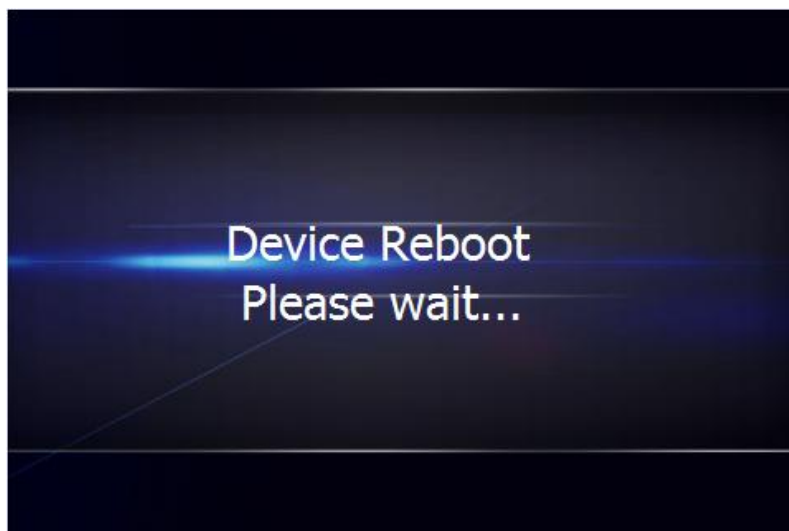

By default, the phone attempts to contact a DHCP server in your network in order to obtain its valid network settings, e.g. IP address, subnet mask, default gateway, DNS server.

Status

You can view the system status of your phone via phone user interface or web user interface. The information of phone status includes: Information (e.g., Model, IPV4, IPV6, MAC, Firmware, Hardware), Network (e.g., WAN Type, IP, Mask, LAN Type, Gateway, DNS ...) Account (e.g., register status of accounts)

To view the phone status via Phone interface :

1. Press Menu → Status → Information

Information	
1.Model:	UC926E
2.IPV4:	192.168.2.26
3.MAC:	00:1f:c1:1c:b1:a0
4.Firmware(IMG):	 2.0.4.4.29(2018-03-05 08:38:00)
5.Firmware(BOOT):	2.0.4.3(2017-12-12 15:33:00)
<input type="button" value="Back"/> <input type="button"/> <input type="button"/> <input type="button"/>	

2. Press Menu →Status →Network

Network	
1.IPV4	
2.IPV6	
3.IP Port Mode:	IPV4&IPV6
4.LAN Type:	Bridge mode
5.MAC:	00:1f:c1:1c:b1:a0
<input type="button" value="Back"/> <input type="button"/> <input type="button"/> <input type="button" value="Enter"/>	

3. Press Menu →Status →Network→IPV4

IPV4	
1.WAN Type:	DHCP mode
2.WAN IP:	192.168.1.111
3.WAN Mask:	255.255.252.0
4.Gateway:	192.168.0.2
5.Pri.DNS:	192.168.0.2
<input type="button" value="Back"/> <input type="button"/> <input type="button"/> <input type="button"/>	

4. Press Menu →Status →Network→IPV6



5. Press Menu →Status →Account (UC926E support sixteen accounts)



To view the phone status via Web interface :

Login webpage (For How to login, please refer to [Web Login](#))

View the information of Version, Account and Network.



[Home](#) | [Profile](#) | [Account](#) | [Network](#) | [Function Keys](#) | [Setting](#) | [Directory](#) | [Management](#)

Status

- **Version** ?

Product Model	UC926E
Firmware Version	BOOT--2.0.4.3(2017-12-12 15:33:00) IMG--2.0.4.4.29(2018-03-05 08:38:00) ROM--2.0.4.4.29(2018-03-05 08:38:00) DSP--9.0.3(Patch 1.0.16M)
- **Account Status** ?

Account1	Registered
Account2	Disabled
Account3	Disabled
Account4	Disabled
Account5	Disabled
Account6	Disabled
Account7	Disabled
Account8	Disabled
Account9	Disabled
Account10	Disabled
Account11	Disabled
Account12	Disabled
Account13	Disabled
Account14	Disabled
Account15	Disabled
Account16	Disabled
- **Network** ?

NOTE

Version:
Shows product type and the version of firmware.

Account Status:
Shows the registered status of accounts.

Network:
Shows the detail information of WAN port and LAN port.

System Up Time:
Shows the running time after device power up.

Restart:
Restart the voip application

Registration

To register via Phone interface:

1. Press Menu → Settings → Advanced Setting (default password: **admin**) → Accounts
2. Select the desired account
3. Select Enable for Account active
4. Select the desired profile of the account.
5. Fill the SIP User ID, Authenticate ID
6. Fill the Password and Name (shown on LCD).

7. Press Save to save the configuration.

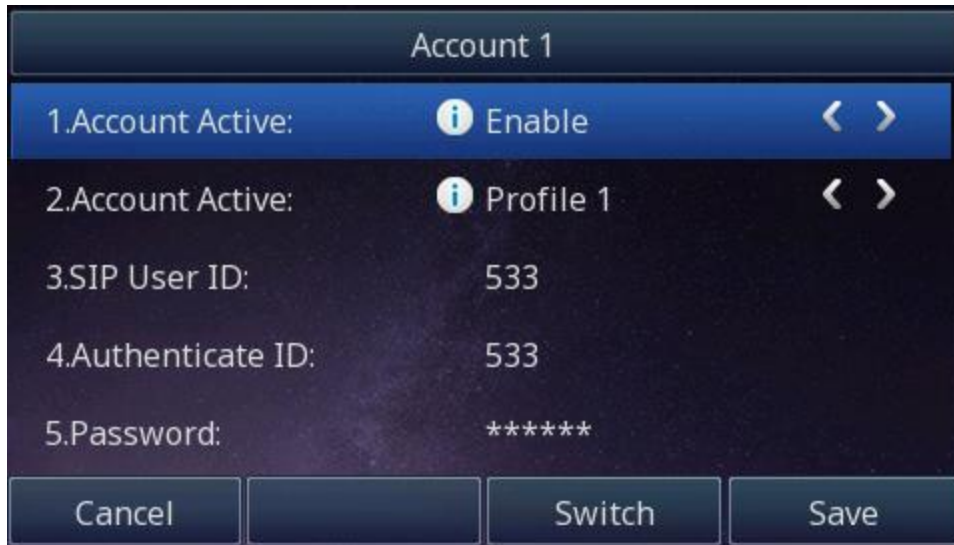

Note:

If there is a port of sip server, you need to press “1” on the keypad, then you will find the “.”.

Additional Information:

When the current input method is ABC/abc/2ab,

Pressing “1”, you will find “?”

Pressing “0”, you will find “< > () {} []”

Pressing “*”, you will find “*/! @\$”

Pressing “#”, you will find “#’%&*|”

To register via Web interface:

1. Login webpage and Click Profile→ Basic

Profile Profile 1

* Primary SIP Server 192.168.0.9

Failover SIP Server

Second Failover SipServer

Prefer Primary SIP Server No Yes

Current SIP Server 192.168.0.9

DHCP SIP Server No Yes

Outbound Proxy

Backup Outbound Proxy

* SIP Transport UDP TCP TLS

NAT Traversal No No, but send keep alive STUN

DNS Mode A Record SRV NAPTR/SRV

Call Message Format Regular

SIP Registration No Yes

Unregister On Reboot No Yes

Register Expiration 15

Outgoing Call Without Registration No Yes

RPort No Yes

RFC 2543 Hold No Yes

SaveSet Restart

NOTE

The * fields must be filled (requires a phone restart)

Basic:
The Basic parameters configured by the administrator.

Codecs:
Select the codec you want to use.

Advanced:
The advanced parameters configured by the administrator.

2. Fill the Primary SIP Server and other profile information.

3. Select the SIP Transport.

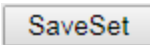
4. Click  to save the configuration.

5. Click Account → Basic.

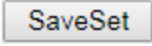
6. Select Yes for Account Active.
7. Select the desired Profile.
8. Fill the SIP User ID, Authenticate ID, Authenticate Password and other account information.
9. Click  to save the configuration.

To register via DHCP SIP Server:

1. Login web page and Click Profile → Basic

Htek

[Home](#) | [Profile](#) | [Account](#) | [Network](#) | [Function Keys](#) | [Setting](#) | [Directory](#) | [Management](#)

Basic

Codec

Advanced

Profile

Profile 1

* Primary SIP Server ?

Fallover SIP Server ?

Second Fallover SipServer ?

Prefer Primary SIP Server No Yes ?

Current SIP Server

DHCP SIP Server No Yes

Outbound Proxy ?

Backup Outbound Proxy ?

* SIP Transport UDP TCP TLS ?

NAT Traversal No No, but send keep alive STUN

DNS Mode A Record SRV NAPTR/SRV

Call Message Format

SIP Registration No Yes

Unregister On Reboot No Yes

Register Expiration ?

Outgoing Call Without Registration No Yes

RPort No Yes

RFC 2543 Hold No Yes

NOTE

The * fields must be filled (requires a phone restart)

Basic:
The Basic parameters configured by the administrator.

Codecs:
Select the codec you want to use.

Advanced:
The advanced parameters configured by the administrator.

2. Fill the Primary SIP Server and other profile information.
3. Select Yes for the DHCP SIP Server and select the SIP Transport.
4. Click to save the configuration.
5. Click Account → Basic.

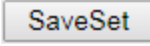
6. Select Yes for Account Active.
7. Select the desired Profile.
8. Fill the SIP User ID, Authenticate ID, Authenticate Password and other account information.
9. Click  to save the configuration.

Note:

1. All fields with * must be filled. If changed, it requires a phone restart.
2. Account Status says the account registered successfully or not.

Idle Screen

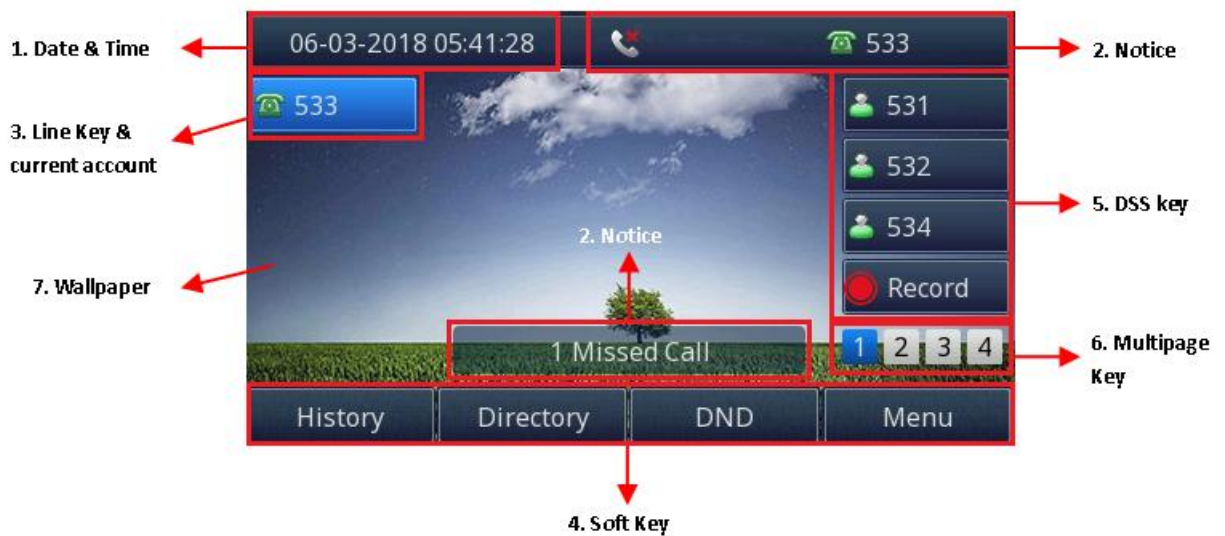







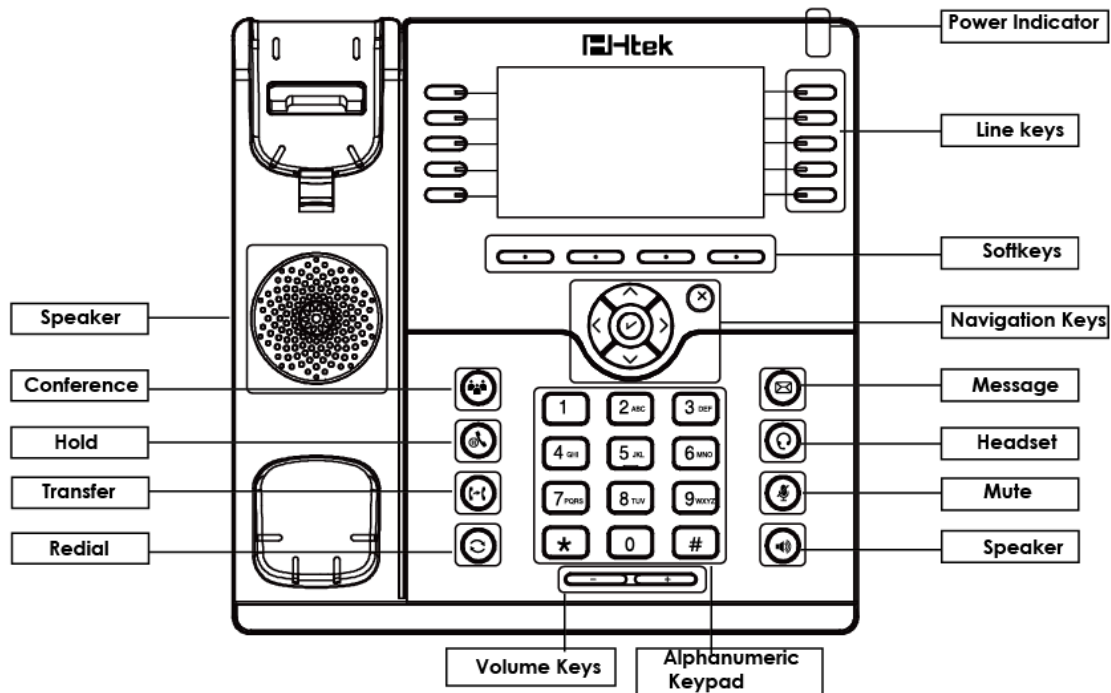

Name	Description
1. Date & Time	It is the area that displays the current set date and time of the phone.
2. Notice	It is the area to display the phone's notifications such as missed calls, SMS, do not disturb mode and many more. For more info, see Icon Preview .
3. Line Keys	This area shows the line key labels. The current account is highlighted. you can switch the account by pressing right or left navigation key. The Line keys can also be used for other function keys. For more info, you can refer to Line Keys
4. Soft Key	This area shows the soft key labels. The default soft key labels are "History", "Directory", "DND" and "Menu". For more info, see Programmable Key
5. DSS Key	The Line keys can be used for other functions keys (e.g.: BLF)
6. Multipage Key	UC924 support 36 keys,you can configure different types.You can view and use these keys by pressing the multipage key.
7. Wallpaper	This shows the current wallpaper picture. You can also change it. For more info, you can refer to Wallpaper .









Getting Familiar with Your Phone

Hardware Components Preview





























Item	Description
LCD screen	To Presentation all information about the date& time, accounts, soft keys, messages, calls and other some information.
Power Indicator LED	To indicate the power status
Line keys	The phone supported up to 4 accounts 1. Steady green: idle interface, during a call.. 2. Blink red: a call incoming
Soft keys	Labels automatically to identify their context-sensitive features.
Navigation keys	<p> 1. OK.</p> <p> Up arrow key: To move up of the selection shows on the screen.</p> <p> Right arrow key: To move right of the selection shows on the screen.</p> <p> Left arrow key: To move left of the selection shows on the screen.</p> <p> Down arrow key: To move down of the selection shows on the screen.</p>

















	 <ol style="list-style-type: none"> 1. To return to idle screen. 2. To cancel the information or call on the screen.
<p>Mute key</p>	 <ol style="list-style-type: none"> 1. To mute the voice during the call (Red light). 2. To un-mute the call.
<p>Conference</p>	 <p>To place a conference call</p>
<p>Line Keys</p>	<p>To be configured as different function as:</p> <ol style="list-style-type: none"> 1. Line 2. Speed Dial 3. BLF 4. BLF List 5. Voice Mail 6. Direct Pickup 7. Group Pickup 8. Call Park 9. Intercom 10. DTMF 11. Prefix 12. Local Group 13. XML Group 14. XML Browser 15. LDAP 16. Network Directories 17. Conference 18. Forward 19. Transfer 20. Hold 21. DND 22. Redial 23. Call Return 24. SMS 25. Record 26. URL Record 27. Paging 28. Group Listening 29. Public Hold 30. Private Hold 31. Hot Desking 32. ACD 33. Zero Touch 34. URL



	<p>35. Network Group</p> <p>36. Multicast Paging</p> <p>37. Group Call Park</p> <p>38. CallPark Retrieve</p> <p>39. Pull Call</p> <p>40. Shared Line</p> <p>The LED lights status when set as Shared line:</p> <p>Stay green: Idle</p> <p>Stay red: Busy</p> <p>Blinked green: Ring Back</p> <p>Blinked red: A call incoming</p> <p>Steady orange: During a call</p> <p>Blinked orange: Public Hold</p> <p>Blinked green: Private Hold</p> <p>Light Drown: Unregistered</p> <p>41. Broadsoft group</p>
Speaker	 Press this button to place a call in hands-free mode.
Redial	 <p>To dial the previous dialed number.</p> <p>To act as send key.</p>
Volume	 <p>To decrease the volume.</p>  <p>To increase the volume.</p>
Hold	 To hold or to resume a call during a conversation.
Transfer	 <p>To transfer a call to a third party.</p> <p>To enable or disable Forward feature during the idle page.</p>
Alphanumeric keypad	To enter the phone numbers, letters and so on.
Message	 To indicator the New message, and press to read.
Headset	 To indicate that the phone is or not in Headset mode.

Icon Preview

Icon	Description
	Network down
	Line(Registered succeed)
	Line (Unregistered)
	Line(Ringing)
	Speed Dial
	BLF
	BLF(Ringing)
	BLF(Talking)
	Speakerphone mode
	Handset mode
	Headset mode
	Voice messages

	Text message
	Mute
	Do Not Disturb
	Volume is 0
	SRTP
	Hold
	Dialed calls
	Received calls
	Missed calls
	Forward calls
	Conference
	Keypad locked
	Pick up
	Call Park

	Intercom/Paging
	DTMF
	Prefix
	XML Group
	Local Group
	XML Browser
	LDAP
	Broadsoft Group
	Conference
	Forward
	Transfer
	Hold
	Redial
	Call Return
	Record
	Stop Recording
	Group Listening

	Shared Line
	Other Functions

LED Instruction

This part mainly instructs the LED status. The Power LED Status describe on the premise that the LED setting all set as Yes. For LED status setting, please refer to: [LED Status Setting](#)

Power Indicator LED

LED Status	Description
Blinked green	Ringling or have missed call
Steady Green	Idle status (Power on)
Off	Powered off.

Line LED:(Line Key set as Line)

LED Status	Description
Steady Green	Hold
Steady Green	Off hook or during a conversation.
Blinked red	Ringling.
Off	Idle status

BLF or BLF List Key LED :(Line/Line Key set as BLF)

LED Status	Description
------------	-------------

Steady Green	Idle status for the monitored line
Steady Red	The monitored line is calling or during a call
Blinked red	The monitored line is ringing.
Off	All other unknown status

Shared Line LED:

LED Status	Description
off	Idle status
Stay green	a member of the SCA group in off-hook status
Stay red	Other member of the SCA group's led status when a member of the SCA group in off-hook status
Blinked green every 500ms	a member of the SCA group in Private hold status.
Stay red	Other member of the SCA group's led status when a member of the SCA group in Private hold status
Blinked green every 500ms	a member of the SCA group in public hold status
Blinked red every 500ms	Other member of the SCA group's led status when a member of the SCA group in public hold status
Blinked green every 500ms	a member of the SCA group in progress status
Stay red	On Other member of the SCA group's led status when a member of the SCA group is in progressing status.
Blinked red every 100ms	Alerting
Stay green	a member of the SCA group in active status when there is an incoming call designated for the SCA group
Stay red	Other member of the SCA group's led status when a member of the SCA group in active status

Other Key Led

Key	Description
Headset Key	When using in headset mode, the led is steady green or the LED is off.
Message Key	Blinked green when there is a new message or the LED is off.
Mute Key	Red when the mute the call, or the LED is off.

User Interface

There are two ways to customize specific configurations on your IP phone:

- The user interface on the IP phone
- The user interface in a web browser on your PC

The hardware components keypad and LCD screen constitute the phone user interface, which allows the user to execute all call operation tasks and basic configuration changes directly on the phone. In addition, you can use the web user interface to access all configuration settings. In many instances, it is possible to use both the phone user interface and the web user interface to operate the phone and change settings. However, in some instances, it is only possible to use the phone or the web user interface.

Phone Interface Overview

Option	
Status	Information
	Network
	Accounts
Features	Call Forward
	Function Keys (Line and Line Key setting)
	More Key see Line Key Overview
	Key as Send
	Hot Line
	Anonymous Call
	DND
History Setting	
Directory	All Contacts
	Local Contacts

	BlackList
History	Local History
	Network CallLog
Message	Voice Mail View and Set.
	Text Message View and Set.
Basic Setting	Language
	Time & Date
	Time & Date Format
	DHCP Time
	Ring tone
	Headset
	Bluetooth
	Wi-Fi
	Font Size
Advanced Setting	Accounts
	Network
	Phone Setting
	Auto Provision
Display	Display Mode
	Wallpaper
	Screensaver
	Backlight
Others	Factory Function
	System Restart
	Device Reboot
	Pcap Feature

Line Key Function Overview

Line
Speed Dial
BLF
BLF List
Voice Mail

Direct Pickup
Group Pickup
Call Park
Intercom
DTMF
Prefix
Local Group
XML Group
XML Browser
LDAP
Network Directories
Conference
Forward
Transfer
Hold
DND
Redial
Call Return
SMS

Record
URL Record
Paging
Group Listening
Public Hold
Private Hold
Hot Desking
ACD
Zero Touch
URL
Network Group
Multicast Paging
Group Call Park
CallPark Retrieve
Pull Call
Shared Line
Broadsoft group

Basic Setting Configuration

This part will mainly introduce the basic configuration as the Time, Language, and Volume...

General Settings

Web Login

1. Get the IP address: Press Menu → Status → Information.

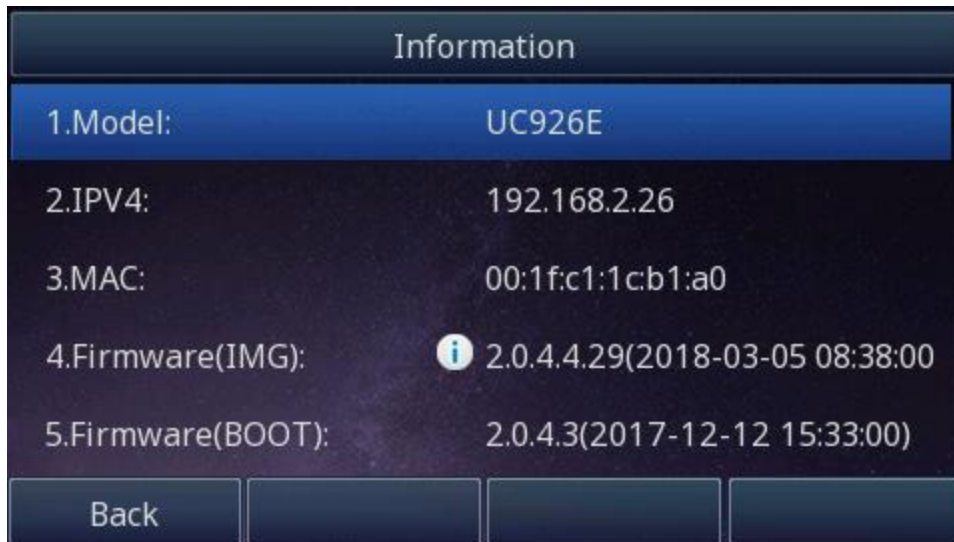

Information	
1.Model:	UC926E
2.IPV4:	192.168.2.26
3.MAC:	00:1f:c1:1c:b1:a0
4.Firmware(IMG):	 2.0.4.4.29(2018-03-05 08:38:00)
5.Firmware(BOOT):	2.0.4.3(2017-12-12 15:33:00)

Back

2. Input the IP Address in the web browser.
3. Input the user name (default is admin), password (default is admin).
4. Login successfully.

[Home](#) | [Profile](#) | [Account](#) | [Network](#) | [Function Keys](#) | [Setting](#) | [Directory](#) | [Management](#)

Status

- **Version** ?

Product Model	UC926E
Firmware Version	BOOT--2.0.4.3(2017-12-12 15:33:00) IMG--2.0.4.4.29(2018-03-05 08:38:00) ROM--2.0.4.4.29(2018-03-05 08:38:00) DSP--9.0.3(Patch 1.0.16M)

- **Account Status** ?

Account1	Registered
Account2	Disabled
Account3	Disabled
Account4	Disabled
Account5	Disabled
Account6	Disabled
Account7	Disabled
Account8	Disabled
Account9	Disabled
Account10	Disabled
Account11	Disabled
Account12	Disabled
Account13	Disabled
Account14	Disabled
Account15	Disabled
Account16	Disabled

- **Network** ?

NOTE

Version:
Shows product type and the version of firmware.

Account Status:
Shows the registered status of accounts.

Network:
Shows the detail information of WAN port and LAN port.

System Up Time:
Shows the running time after device power up.

Restart:
Restart the voip application

Note:
 The PC and phone should be in the same segment.
 When registering the accounts in web and the server port is not "5060", the "SIP Server" should be set as "SIP Server's IP address: server port.", for example, "192.168.0.122: 5090".

Administrator Password

The password is mainly used for login the web interface or set the advanced settings through phone interface. And the default password of the administrator is: **admin**

To change to password via Phone interface

1. Press Menu → Settings → Advanced settings → password (default admin) → Phone Setting → Set Password

2. Enter the current PWD (password), new password and confirm the new password.
3. Press save soft key or  to save the new password.



The image shows a 'Set Password' dialog box with a dark background. It contains three input fields labeled '1.Current PWD:', '2.New PWD:', and '3.Confirm:'. At the bottom, there are four buttons: 'Cancel', '2aB', 'Delete', and 'Save'.

To change to password via Web interface

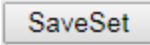
1. Management → Password
2. Fill the value
3. Click  to save the configuration.

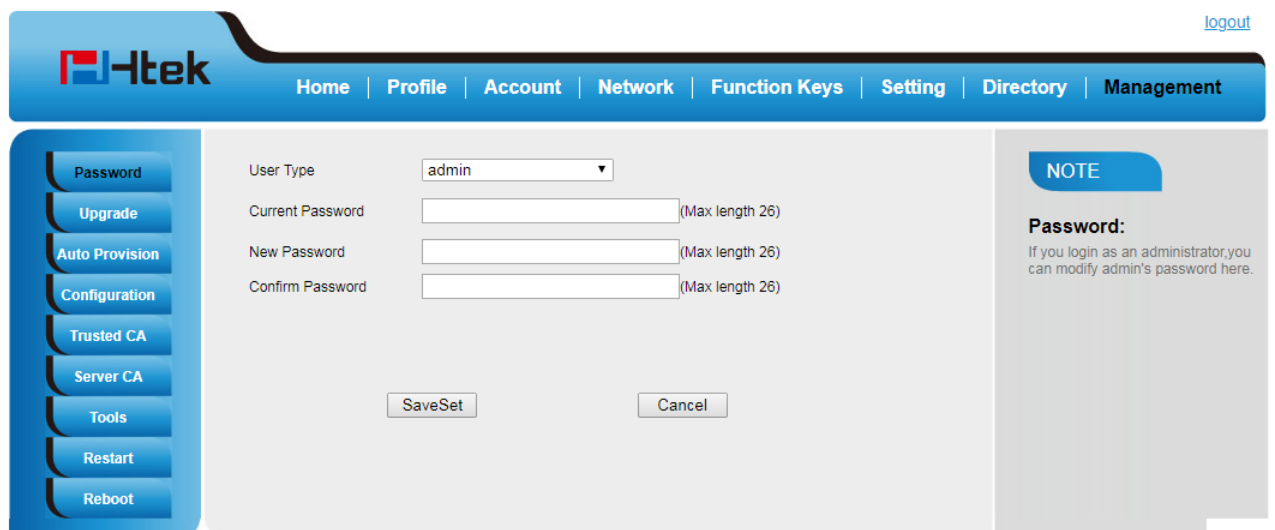

The image shows a web interface for changing the password. The top navigation bar includes the Htek logo and links for Home, Profile, Account, Network, Function Keys, Setting, Directory, and Management. A 'logout' link is in the top right. On the left, a sidebar menu has buttons for Password, Upgrade, Auto Provision, Configuration, Trusted CA, Server CA, Tools, Restart, and Reboot. The main content area has a 'User Type' dropdown set to 'admin', and three input fields for 'Current Password', 'New Password', and 'Confirm Password', each with '(Max length 26)' next to it. At the bottom are 'SaveSet' and 'Cancel' buttons. A 'NOTE' box on the right states: 'Password: If you login as an administrator, you can modify admin's password here.'

Note:

When you use the web interface: user name: admin password: admin(default)

Display Mode

This phone support two Display mode: Text and Icon.

Icon Mode: all Items are shown same as the main with Icon.

Text Mode: Only the 8 main items will be shown as icon, and others all text description.

To Configure Display mode via Phone interface :

1. Press Menu→ Display→ Display Mode
2. Select Text or Icon
3. Press Save soft key to save the configuration.

To Configure Display mode via Web interface :

1. Login web interface, and click Setting→ Preference

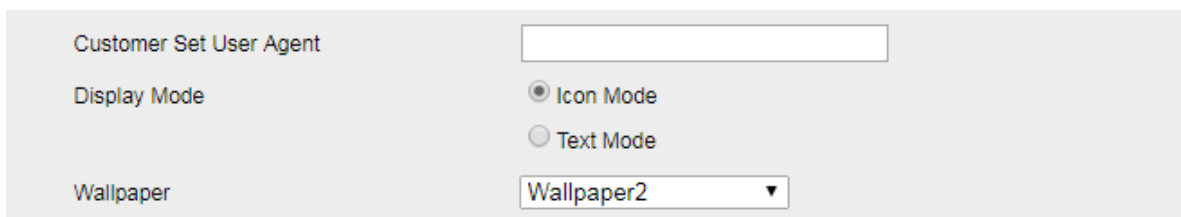

Customer Set User Agent	<input type="text"/>
Display Mode	<input checked="" type="radio"/> Icon Mode <input type="radio"/> Text Mode
Wallpaper	Wallpaper2 ▼

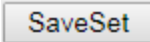
2. Select Icon Mode or Text Mode for the Display mode
3. Click  to save the configuration.

Language

The default Phone interface language is English.

To change the language via Phone interface

1. Press Menu → Settings → Basic Settings → Language.

To change the language via Web interface

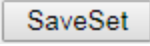
1. Setting → Preference → Web Language & LCD Language
2. Select the necessary one.
3. Press  to save the configuration.

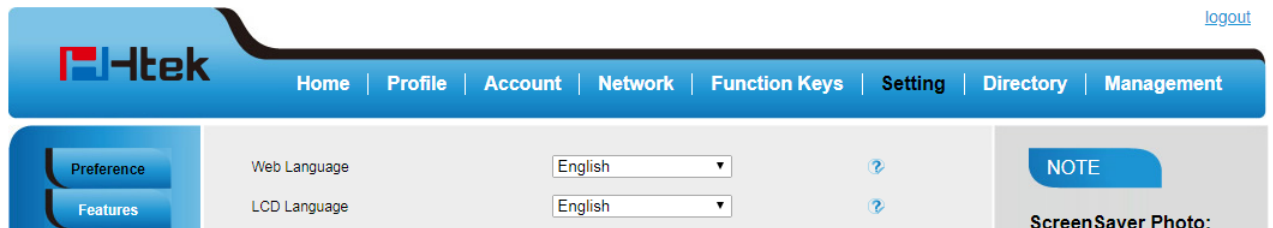

**Note:**

All languages may not be available for selection. The available languages depend on the language packs currently loaded to the IP phone.

Wallpaper

To change wallpaper, go by the following steps:

To change the wallpaper via Phone interface:

1. To press Menu → Display → wallpaper
2. Press  and  or press Switch soft key to display the different pictures.
3. Press  or Save soft key to save the selected picture as the wallpaper.

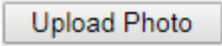

To change the wallpaper via Web interface :

1. Click Setting→ Preference
2. Select the desired wallpaper picture to upload.
3. Click  to save the setting.

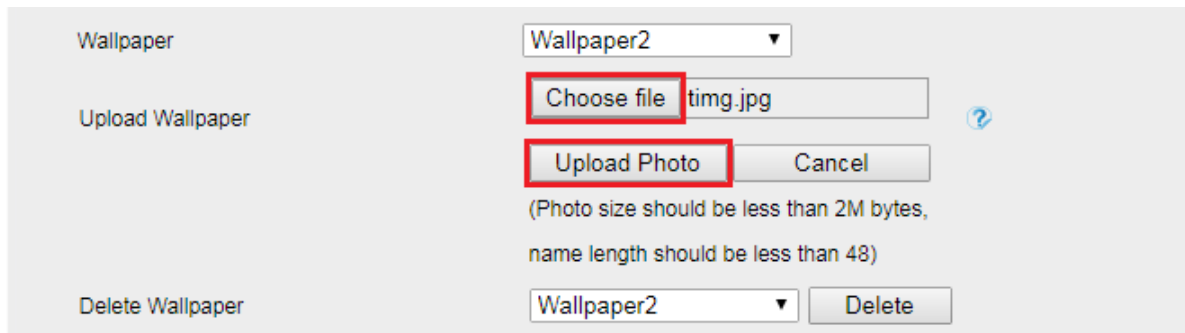
**To delete the wallpaper via Web interface :**

1. Click Setting→ Preference
2. Select the desired wallpaper to delete.
3. Click  to save the setting.

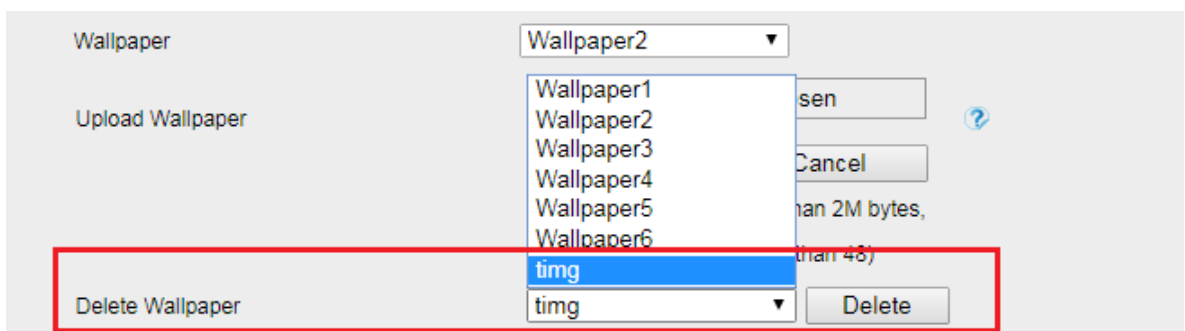
**Note:**

System wallpaper (Wallpaper1-Wallpaper6) cannot be deleted and only color IP Phone support upload wallpaper.

Screen Saver

There are three types of screen saver: Time & Logo, Photo Switch and Static Photo.

Time & Logo: when the screensaver works, it will show Time and logo in turns.



Photo Switch: all screensaver pictures display one by one.

Static Photo: Only the selected picture will display as screensaver.

Text logo: It works with the **Time & Logo**, when enter the value, it will display the time



and the entered value in turns.

To enable screen saver via Phone interface :

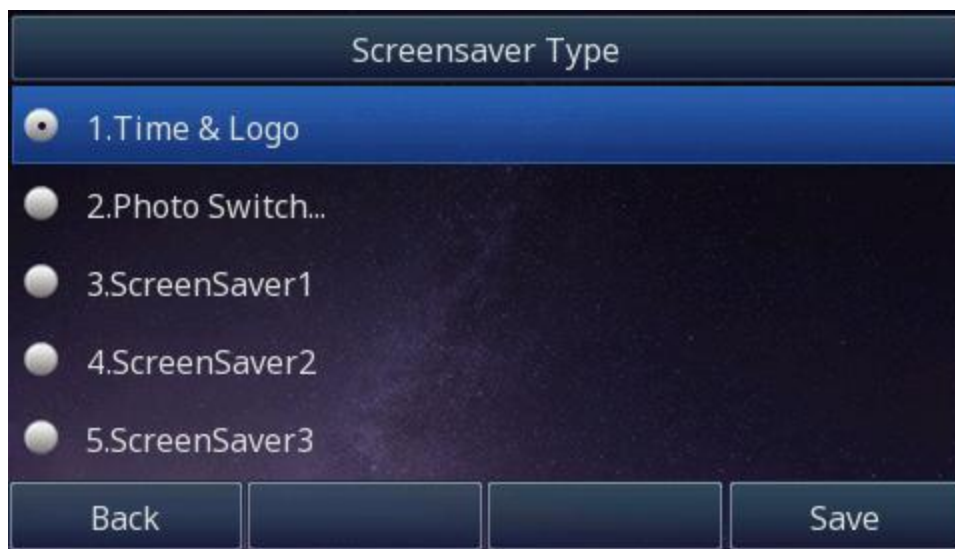
1. To press Menu → Display → Screensaver...
2. Press  and  or press Switch soft key to Choose the Time-out as 1 min or 2/5/10/30 minute.
3. Enter the Screensaver Type to choose one of the type: Backlight off, Time & Logo and Photo
4. Press  or Save soft key to save the selected configuration.



To disable screen saver via Phone interface

1. To press Menu → Display → Screensaver...
2. Press  and  or press Switch soft key to Choose the Time-out as off.
3. Press  or Save soft key to save the selected configuration.

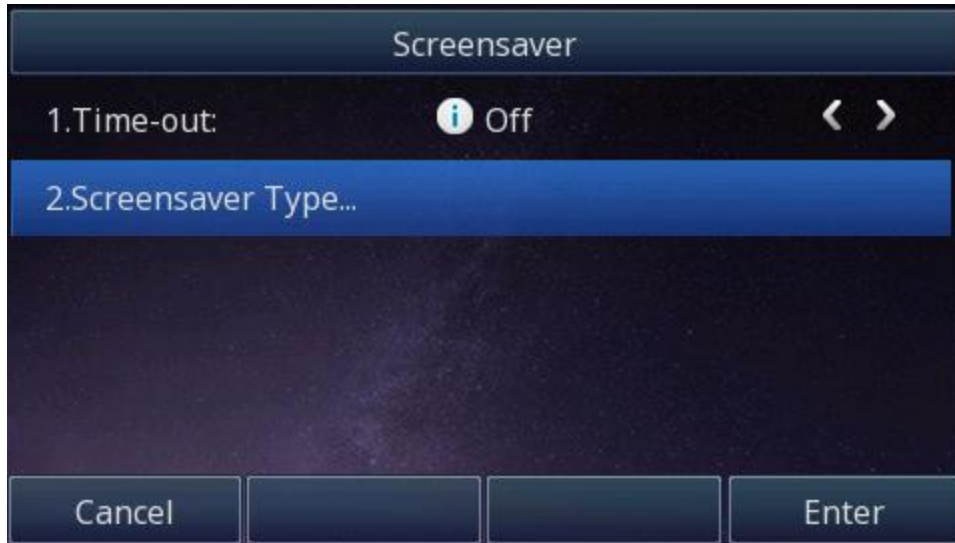

To upload screen saver via Web interface :

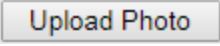
1. Setting → Preference
2. Choose the picture wanted to use as screen saver
3. Click  to save the upload picture

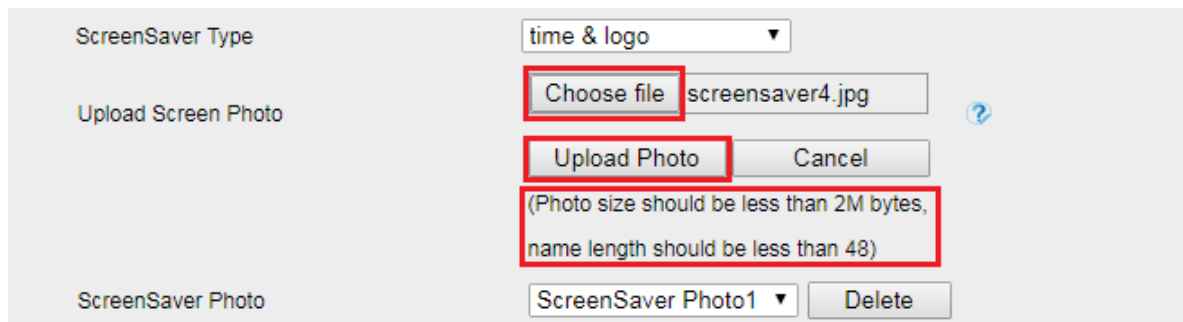

To delete upload screen saver phone via Web interface :

1. Setting → Preference
2. Select the photo that to delete.
3. Click Delete to delete the photo.

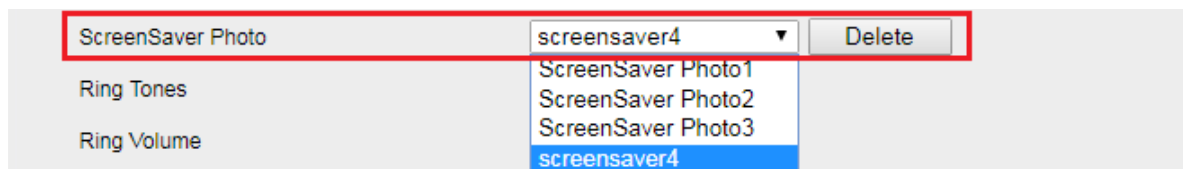

Note:

System Screen Photo (ScreenSaver1-ScreenSaver3) cannot be deleted and only color IP Phone support upload wallpaper.

To custom text logo via Web interface :

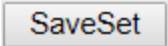
1. Click Setting→ Preference.
2. choose the Time-out as 1 min or 2/5/10/30 minute.
3. Enter the desired value in the Text Logo field.
4. Click  to save the configuration.

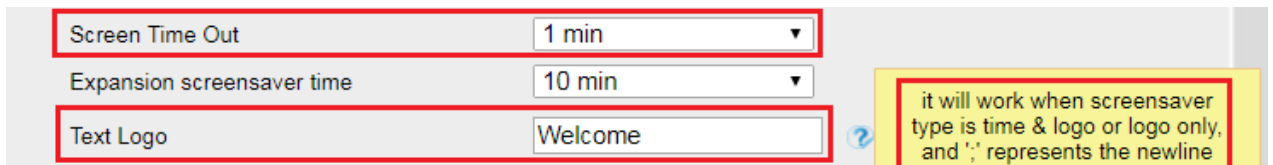

Screen Time Out: 1 min

Expansion screensaver time: 10 min

Text Logo: Welcome

it will work when screensaver type is time & logo or logo only, and '\n' represents the newline

To wake up screen saver via Web interface :

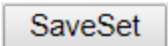
1. Setting → Preference
2. Choose Dial First Digit: Screensaver Wakes up or Screensaver Wakes up and Dial
3. Click  to save the configuration.

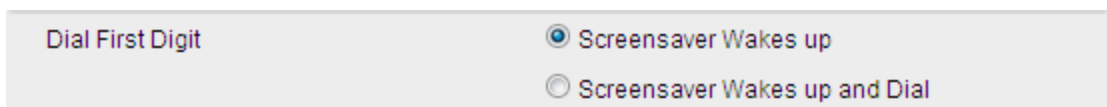

Dial First Digit

Screensaver Wakes up

Screensaver Wakes up and Dial

Note:

1. The upload Photo size should be less than 2MB, name length should be less than 48 characters, and the File name should be letters, numbers or underline '_' and photo number should be less than 9.
2. The default screensaver photos cannot be deleted.
3. You can only upload screen photos in format of '.bmp' and '.jpg'.

Backlight





To set Backlight via Web interface :

1. Click Setting→ Preference
2. Enter the time for Backlight time (In seconds).
The default is 0, which means Backlight is always on.
3. Select the desired value for Backlight Inactive Level and Backlight Active Level.

4. Click to save the configuration.

Backlight Inactive Level	Low	▼
Backlight Active Level	10	▼
Backlight Time	0	?

To set Backlight via Web interface phone interface:

1. To press Menu → Display → Backlight
2. Press  or  to change the Backlight Active Level
3. Press  or  to change the Backlight Inactive Level.
4. Fill the Backlight Time.
5. Press  or Save soft key to save the configuration.

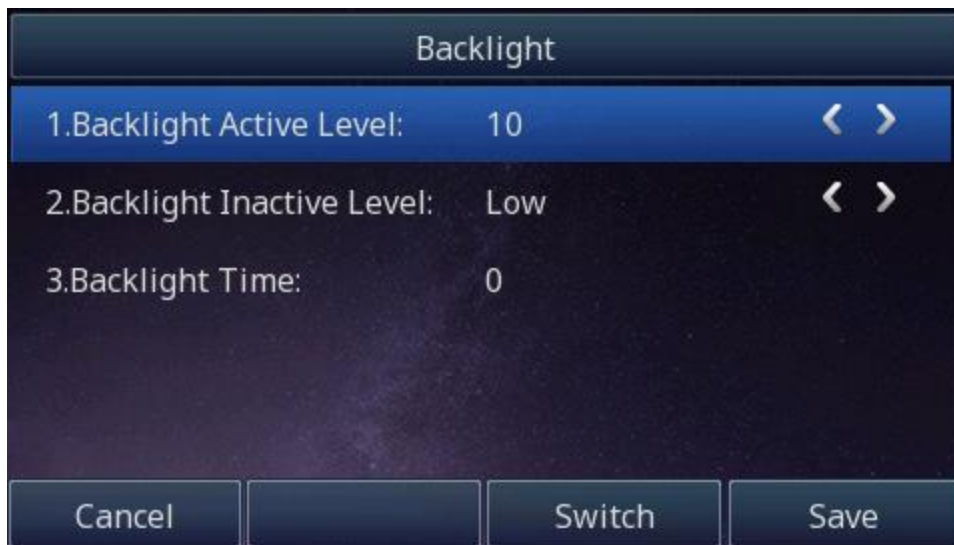



Note:

1. **Backlight Active Level** is used to adjust the brightness of backlight
2. **Backlight Inactive Level** controls the backlight is all dark or brightness can be adjusted
3. **Backlight Time** refers to the time into the backlight



Time and Date

Time and date is displayed on the idle page, and it can be set automatically by SNTP server or manually by manual setting.

To configure the time and Date by SNTP setting via Phone interface





1. To press Menu → Settings → Basic Setting → Time & Date → SNTP Settings
2. Press  or  to change the Time zone.
3. Fill the NTP server1, NTP Server2, and select the mode of Daylight Saving.
4. Press  or Save soft key to save the configuration.

**To configure time and date manually via Phone interface**

1. To press Menu → Settings → Basic Setting → Time & Date → Manual Settings
2. Press  and  or change the right time, or you can input the right time.
3. Press  or Save soft key to save the configuration.



To configure the Time & Date Format via Phone interface

1. Press Menu → Settings → Basic Setting → Time & Date Format
2. Press  and  to change between 12 Hour or 24 Hour time display.
3. Press  and  to change date display format.
4. Press  or Save soft key to save the configuration.

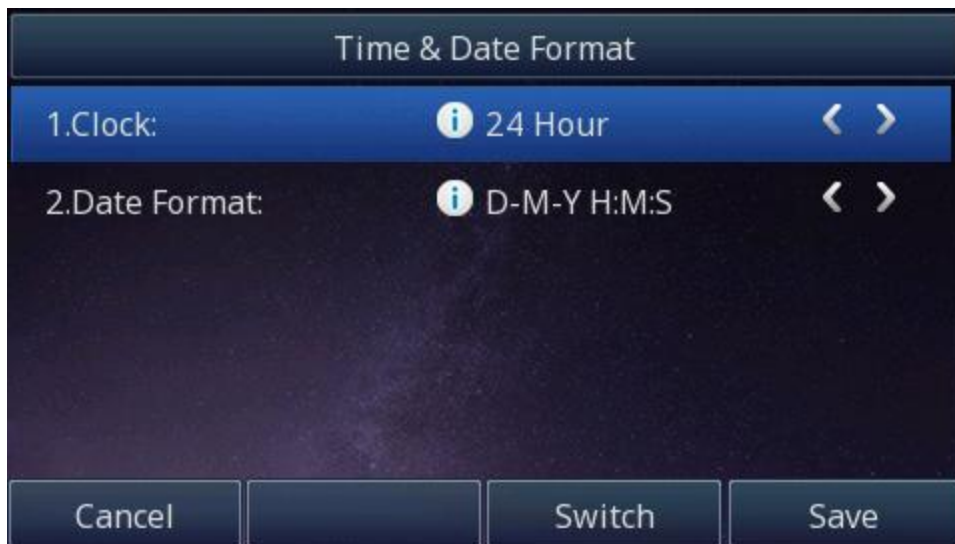

To configure the DHCP time via Phone interface

1. To press Menu → Settings → Basic Setting → DHCP time

2. Press and to change between Disable and Enable.
3. Press or Save soft key to save the configuration.

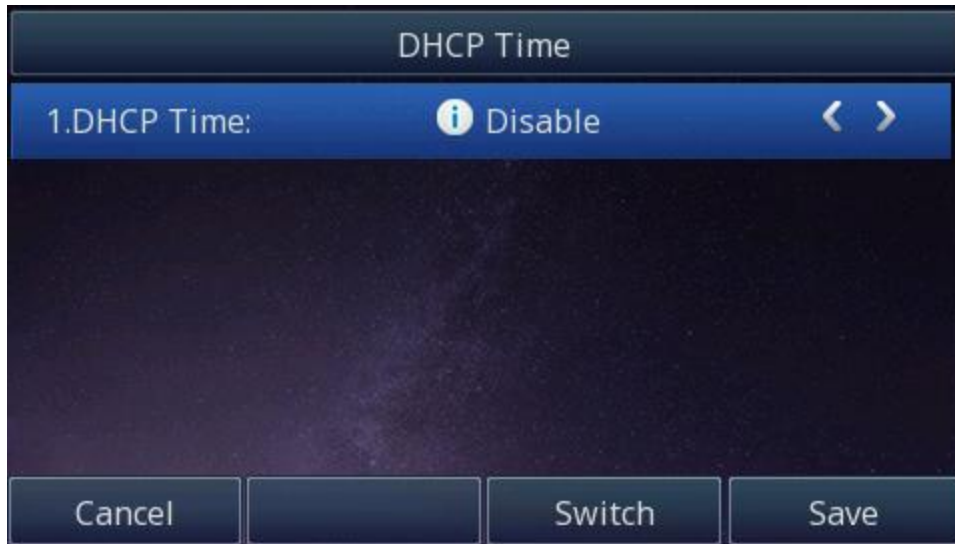

To configure the DHCP Option 100

1. To press Menu → Settings → Date & Time → DHCP Option 100
2. Select Yes for the DHCP SIP Server
3. Click to save the configuration

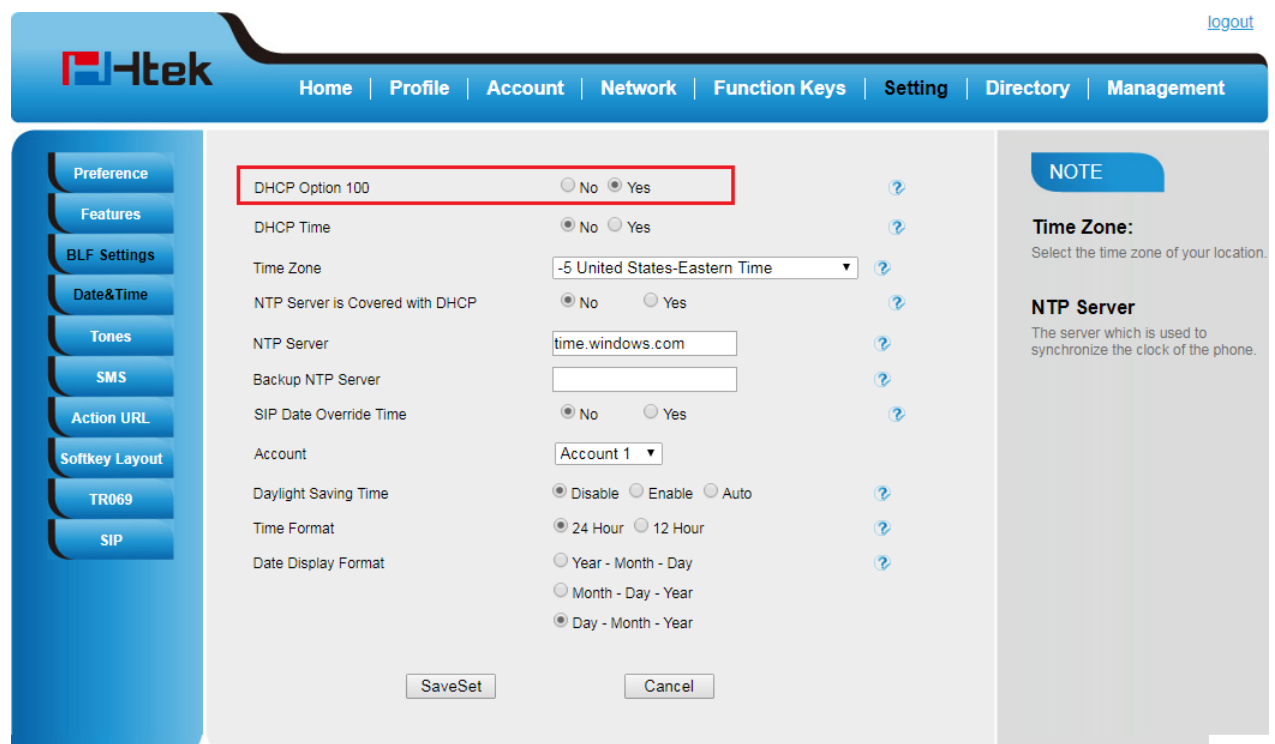

To configure the NTP Server via Web interface

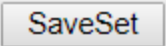
1. Login
Login name: admin, password: admin(default)
2. Setting → Date &Time →NTP Server
3. Fill the value in the blank.
4. Click  to save the configuration.

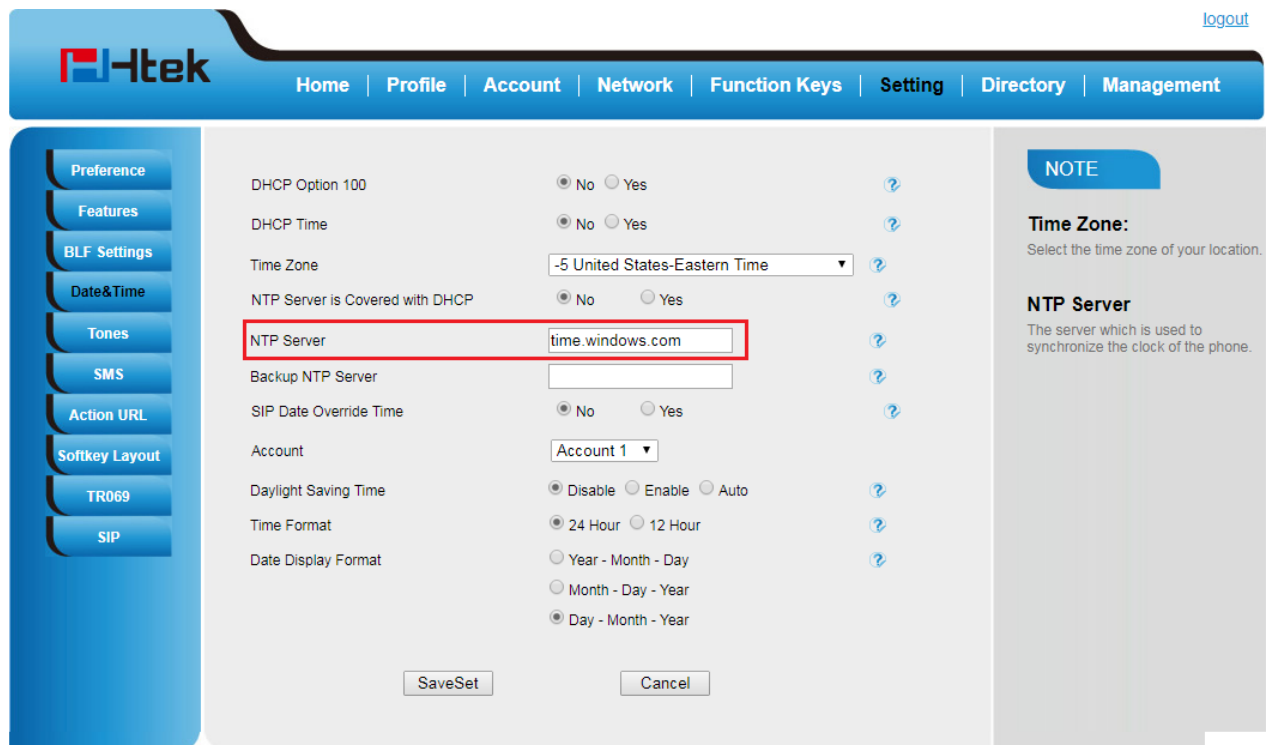

The screenshot shows the Htek web interface with the following configuration options visible:

- DHCP Option 100: No Yes
- DHCP Time: No Yes
- Time Zone: -5 United States-Eastern Time
- NTP Server is Covered with DHCP: No Yes
- NTP Server**: time.windows.com
- Backup NTP Server: (empty field)
- SIP Date Override Time: No Yes
- Account: Account 1
- Daylight Saving Time: Disable Enable Auto
- Time Format: 24 Hour 12 Hour
- Date Display Format: Year - Month - Day Month - Day - Year Day - Month - Year

NOTE
Time Zone:
 Select the time zone of your location.
NTP Server
 The server which is used to synchronize the clock of the phone.

To change the Time Zone and Date Display Format via Web interface

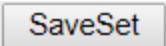
1. Setting → Date &Time
2. Select the necessary one.
3. Press  to save the configuration.

Preference
Features
BLF Settings
Date&Time
Tones
SMS
Action URL
Softkey Layout
TR069
SIP

Home | Profile | Account | Network | Function Keys | **Setting** | Directory | Management

DHCP Option 100 No Yes ?
DHCP Time No Yes ?
Time Zone ?
NTP Server is Covered with DHCP No Yes ?
NTP Server ?
Backup NTP Server ?
SIP Date Override Time No Yes ?
Account ?
Daylight Saving Time Disable Enable Auto ?
Time Format 24 Hour 12 Hour ?
Date Display Format Year - Month - Day ?
 Month - Day - Year ?
 Day - Month - Year ?

NOTE
Time Zone:
Select the time zone of your location.
NTP Server
The server which is used to synchronize the clock of the phone.

To change the SIP Date Override Time via Web interface

1. Setting → Date & Time → SIP Date Override Time
2. Select Yes or No for SIP Date Override Time .
3. Click to save the configuration.

Preference
Features
BLF Settings
Date&Time
Tones
SMS
Action URL
Softkey Layout
TR069
SIP

Home | Profile | Account | Network | Function Keys | **Setting** | Directory | Management

DHCP Option 100 No Yes ?
DHCP Time No Yes ?
Time Zone ?
NTP Server is Covered with DHCP No Yes ?
NTP Server ?
Backup NTP Server ?
SIP Date Override Time No Yes ?
Account ?
Daylight Saving Time Disable Enable Auto ?
Time Format 24 Hour 12 Hour ?
Date Display Format Year - Month - Day ?
 Month - Day - Year ?
 Day - Month - Year ?

NOTE
Time Zone:
Select the time zone of your location.
NTP Server
The server which is used to synchronize the clock of the phone.

To change the Account via Web interface

1. Setting → Date & Time → Account.
2. Select desired Account.
3. Click  to save the configuration.

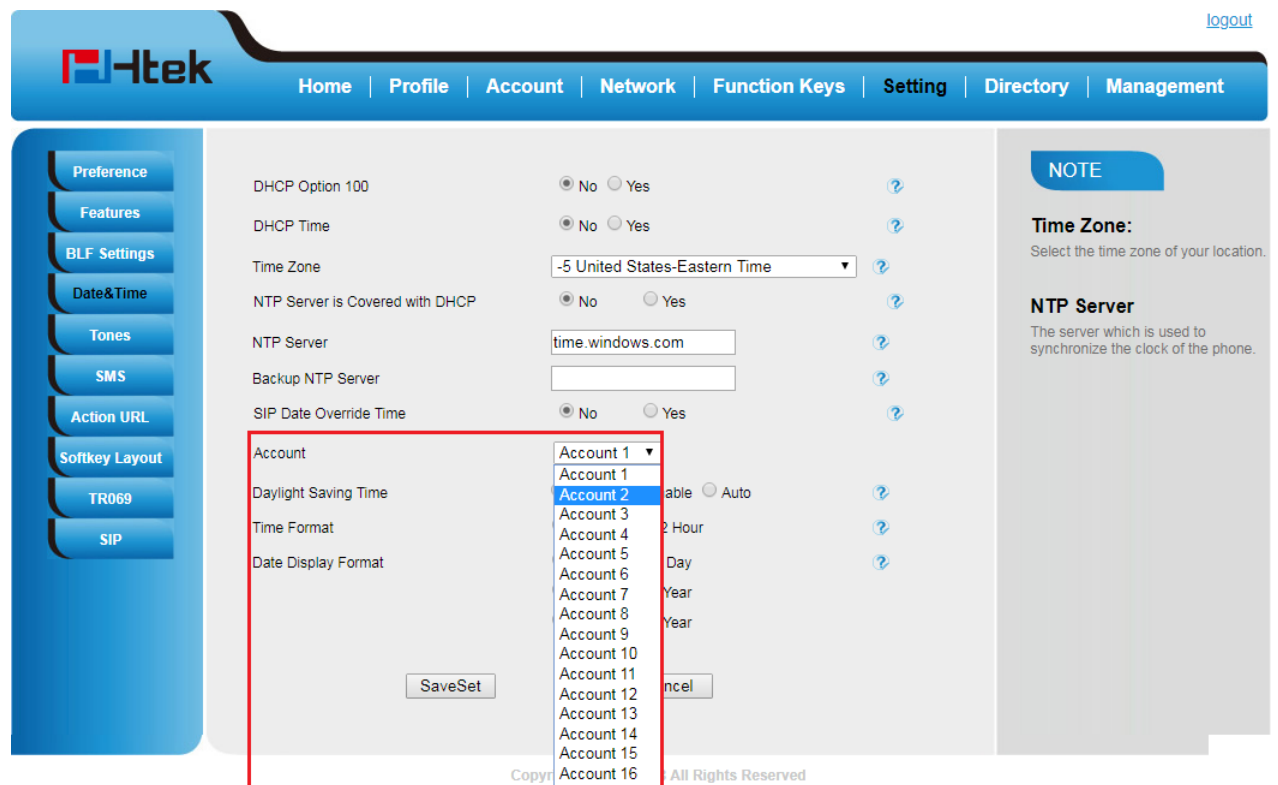

The screenshot shows the Htek web interface with the 'Date & Time' settings page. The 'Account' dropdown menu is open, displaying a list of accounts from Account 1 to Account 16. The 'SaveSet' button is highlighted with a red box. The interface includes a navigation bar with 'Home', 'Profile', 'Account', 'Network', 'Function Keys', 'Setting', 'Directory', and 'Management'. A sidebar on the left contains various settings categories like 'Preference', 'Features', 'BLF Settings', 'Date & Time', 'Tones', 'SMS', 'Action URL', 'Softkey Layout', 'TR069', and 'SIP'. A 'NOTE' section on the right provides information about the 'Time Zone' and 'NTP Server' settings.

To change the Daylight Saving Time via Web interface

1. Setting → Date & Time → Daylight Saving Time
2. Select Disable or Enable or Auto for Daylight Saving Time.
3. Click  to save the configuration.

The screenshot shows the 'Preference' settings page in the Htek web interface. The 'Daylight Saving Time' setting is highlighted with a red box. The settings include:

- DHCP Option 100: No Yes
- DHCP Time: No Yes
- Time Zone: -5 United States-Eastern Time
- NTP Server is Covered with DHCP: No Yes
- NTP Server: time.windows.com
- Backup NTP Server: [Empty field]
- SIP Date Override Time: No Yes
- Account: Account 1
- Daylight Saving Time**: Disable Enable Auto
- Time Format: 24 Hour 12 Hour
- Date Display Format: Year - Month - Day Month - Day - Year Day - Month - Year

Buttons: SaveSet, Cancel

NOTE
Time Zone:
 Select the time zone of your location.
NTP Server
 The server which is used to synchronize the clock of the phone.

Note:
 If the IP Phone cannot obtain the time and date from the Simple Network Time Protocol (SNTP) server, please contact your system administrator for more information.

Daylight Saving Time

Daylight Saving Time (DST) is the practice of temporary advancing clocks during the summertime so that evenings have more daylight and mornings have less. Typically, clocks are adjusted forward one hour at the start of spring and backward in autumn. Many countries have used the DST at various times, details vary by location. The DST can be adjusted automatically from the time zone configuration. Typically, there is no need to change this setting

LED Status Setting

The LED Status setting mainly defines the power indicator LED.

To configure LED Status via Web interface :

1. Click Setting → Preference
2. Select Yes or No for Power Status, Ringing Status, Miss Calls Status and Voice Message Status.

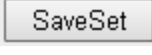

- Click  for the setting.

For the LED status description, see: LED Instruction [Power Indicator LED](#)

LED Status Setting:		
Power Status	<input checked="" type="radio"/> Yes	<input type="radio"/> No
Ringing Status	<input checked="" type="radio"/> Yes	<input type="radio"/> No
MissCalls Status	<input type="radio"/> Yes	<input checked="" type="radio"/> No
Voice Message Status	<input type="radio"/> Yes	<input checked="" type="radio"/> No

Key as Send

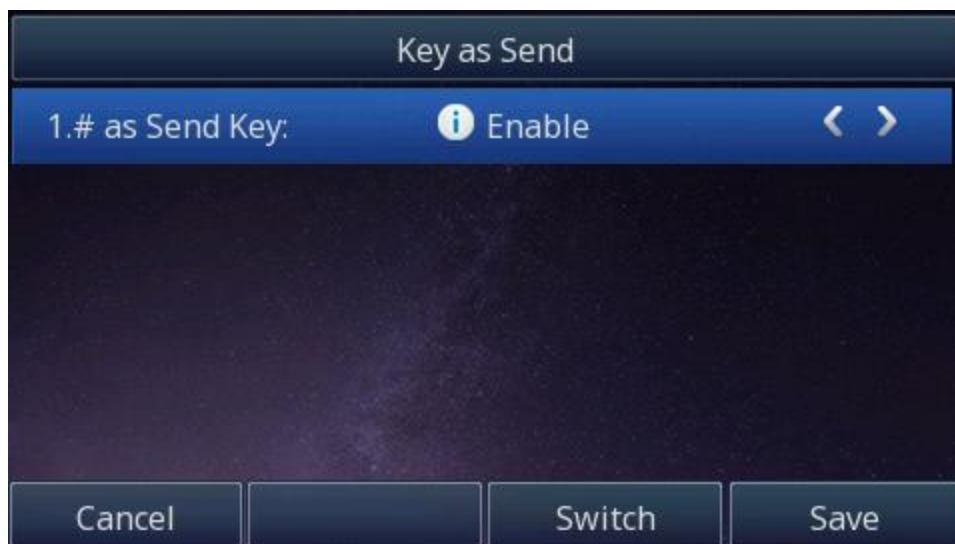

To configure Key as Send via Phone interface :

- Press Menu → Features → Key as Send
- Press  and  key to select the enable choice.
- Press  or Save soft key to save the configuration



To cancel # Key as Send via Phone interface :

- Press Menu → Features → Key as Send

2. Press  and  key to select the disable choice.
3. Press  or Save soft key to save the configuration

Network Setting

Htek IP Phone supports IPv4, IPv6, IPv4&IPv6.They have three mode of Network: DHCP, Static, and PPPoE. The default mode is DHCP, it will obtain IP address and other information automatically.

If your phone cannot contact a DHCP server for any reason, you need to configure a static IP address manually.

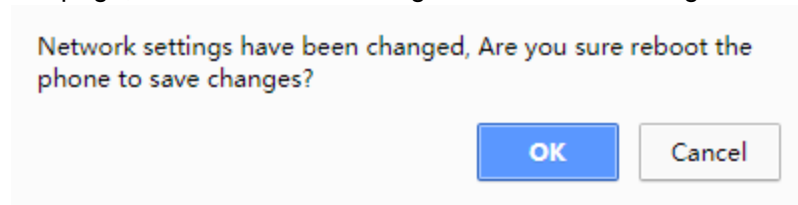

When switch DHCP, Static IP and PPPoE to each other, or change the Static IP on webpage, it will show the warning of restart as following.



IPv4

If you set IP Mode to IPv4,IP phone will use IPv4 address. IPv4 has three network modes: DHCP, Static, and PPPoE

To configure IPv4 via Phone interface :

1. Press Menu→ Settings→ Advanced Setting (password: admin) → Network→ WAN Port → IP Port Mode.
2. Press  or  to change the IP Port Mode..
3. Press  or Save soft key to save the configuration.

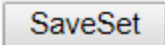

To configure IPv4 via Web interface :

1. Click Network→ Basic→ Internet Port
2. Select IPv4 for Internet Port
3. Click  for the setting.

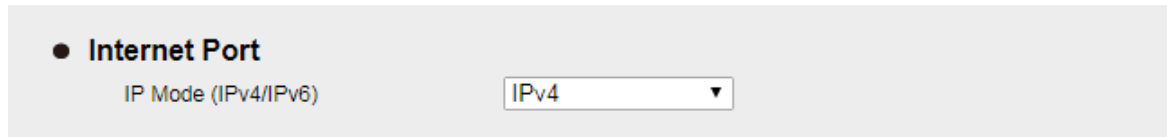

To configure DHCP via Phone interface :

1. Press Menu→ Settings→ Advanced Setting (password: admin) → Network→ WAN Port IPv4→ DHCP mode.
2. Click Save and restart the phone.

To configure a static IP address via Phone interface :

1. Press Menu→ Settings→ Advanced Setting (password: admin) → Network→ WAN Port → IPv4 → Static mode.
2. Enter the parameters: IP, Netmask, Gateway, Pri.DNS(primary DNS), Sec.DNS (second DNS) in the corresponding fields.

Static mode			
1.IP:	192.168.1.111		
2.Netmask:	255.255.252.0		
3.Gateway:	192.168.0.2		
4.Pri.DNS:	114.114.114.114		
5.Sec.DNS:	8.8.8.8		
Cancel	123	Delete	Save

- Click Save and restart the phone.

Static mode			
1.IP:	192.168.1.111		
2.Netmask:	255.255.252.0		
3.Gateway:	192.168.0.2		
4.Pri.DNS:	114.114.114.114		
5.Sec.DNS:	8.8.8.8		
Cancel			OK

NOTE

System will restart, Are you sure ?

- Press the OK soft key to accept the change or the Cancel soft key to cancel. If you are using an xDSL modem, you can connect your phone to the Internet via PPPoE mode. You can set a WAN port to be a PPPoE port. The PPPoE port will perform a PPP negotiation to obtain the IP address. Contact your system administrator for the PPPoE user name and password.

To configure PPPoE via Phone interface:

- Press Menu → Settings → Advanced Setting (password: admin) → Network → WAN Port → PPPoE mode.
- Enter the User ID and password

3. Click Save and restart the phone.

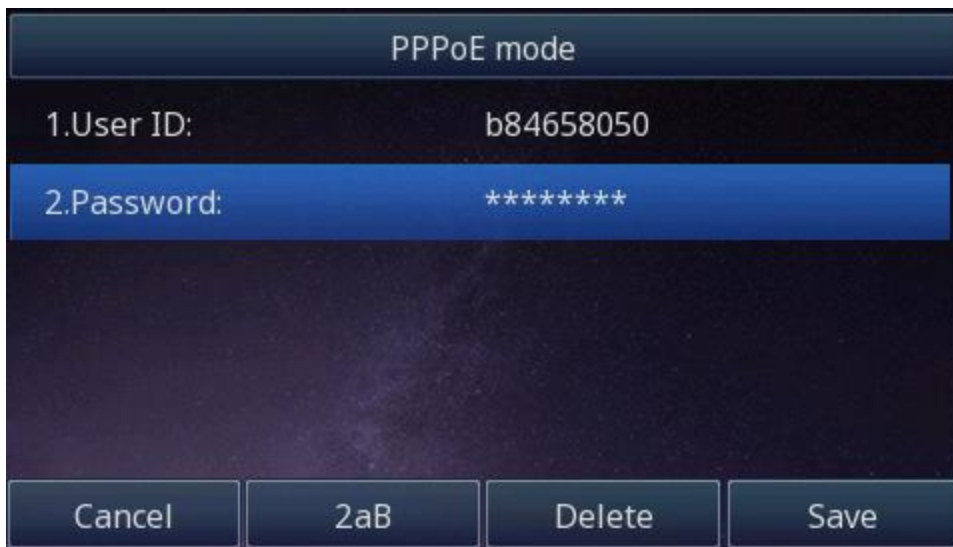

To configure Network via Web interface :

1. Click Network→ Basic→ IPv4 setting
2. Select the desired Type: DHCP, Static or PPPoE
3. Filled the necessary information.
4. Click the SaveSet and restart the phone.

[logout](#)

Home |
 Profile |
 Account |
 Network |
 Function Keys |
 Setting |
 Directory |
 Management

Basic

PC Port

Advanced

Internet Port

IP Mode (IPv4/IPv6) IPv4

IPv4 Setting

DHCP ?

DHCP HostName

DHCP Domain

DHCP Vendor Class Id

DHCP User Class

Static IP Address ?

IP Address . . .

Subnet Mask . . .

Default Gateway . . .

Static DNS No Yes

Primary DNS . . .

Secondary DNS . . .

PPPoE ?

Account ID

PassWord

Service Name

Preferred DNS Server . . .

NOTE

DHCP:
The phone will obtain the network configuration from a DHCP server.



Static IP Address:
Manually input the IP address, subnet mask, default gateway address, and Primary and Secondary DNS addresses

PPPoE:
Please check with your network administrator or service provider before changing this setting

IPv6

If you set IP Mode to IPv6, IP phone will use IPv6 address. IPv4 has two network modes: DHCP, Static

To configure IPv6 via Phone interface:

1. Press Menu → Settings → Advanced Setting (password: admin) → Network → WAN Port → IP Port Mode.
2. Press  or  to change the IP Port Mode..
3. Press  or Save soft key to save the configuration.

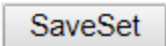

To configure IPv6 via Web interface:

1. Click Network → Basic → Internet Port
2. Select IPv6 for Internet Port
3. Click  for the setting.

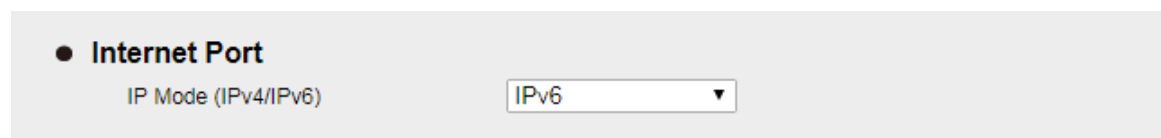

To configure DHCP via Phone interface:

1. Press Menu → Settings → Advanced Setting (password: admin) → Network → WAN Port IPv6 → DHCP mode.

2. Click Save and restart the phone.

To configure a static IP address via Phone interface :

1. Press Menu→ Settings→ Advanced Setting (password: admin) → Network→ WAN Port → IPv6 → Static mode.
2. Enter the parameters: IP, IPV6 Prefix, Gateway, Pri.DNS(primary DNS), sec.DNS (second DNS) in the corresponding fields.

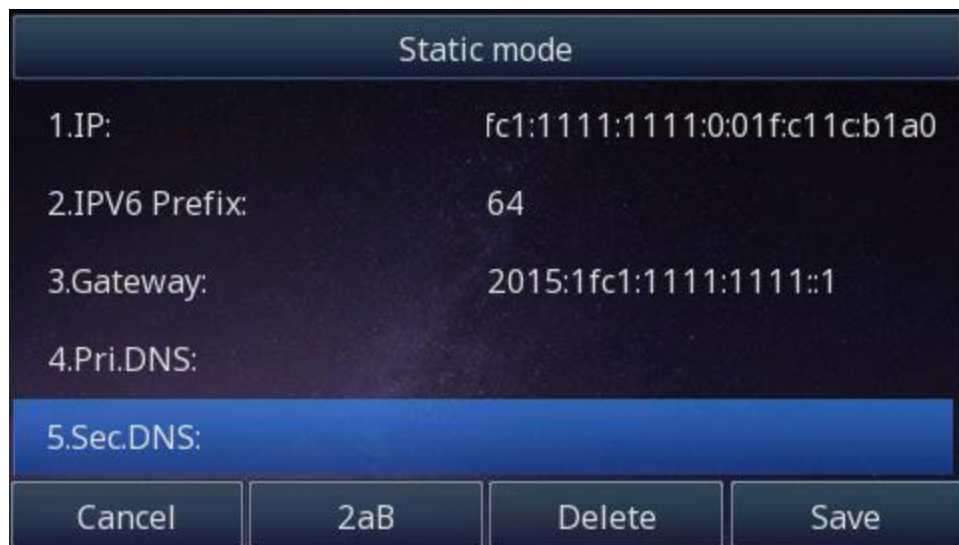

Static mode	
1.IP:	fc1:1111:1111:0:01f:c11c:b1a0
2.IPV6 Prefix:	64
3.Gateway:	2015:1fc1:1111:1111::1
4.Pri.DNS:	
5.Sec.DNS:	

Buttons: Cancel, 2aB, Delete, Save

3. Click Save and restart the phone.

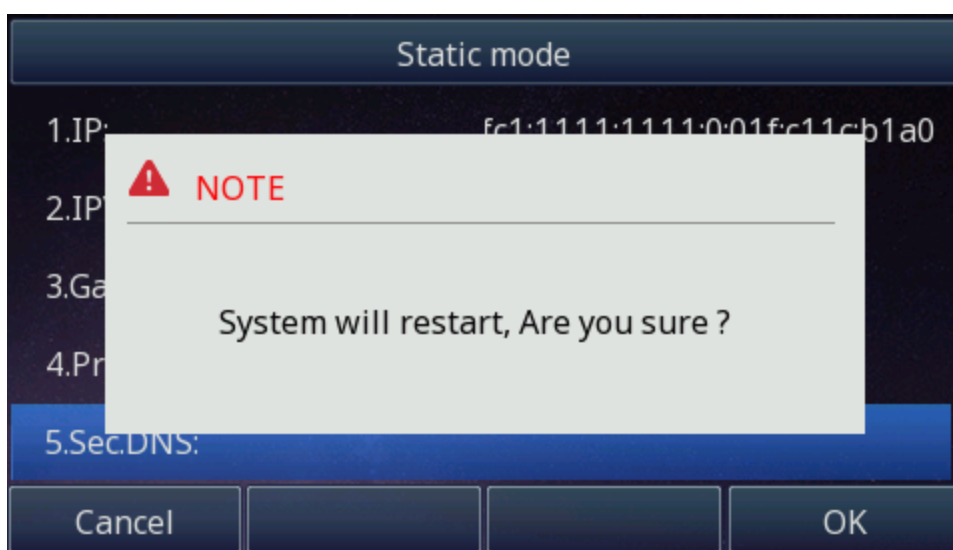

Static mode	
1.IP:	fc1:1111:1111:0:01f:c11c:b1a0
2.IP:	
3.Ga	
4.Pr	
5.Sec.DNS:	

NOTE

System will restart, Are you sure ?

Buttons: Cancel, OK

To configure Network via Web interface :

1. Click Network→ Basic→ IPv6 setting
2. Select the desired Type: DHCP, Static
3. Fill required fields.
4. Click the SaveSet and restart the phone.

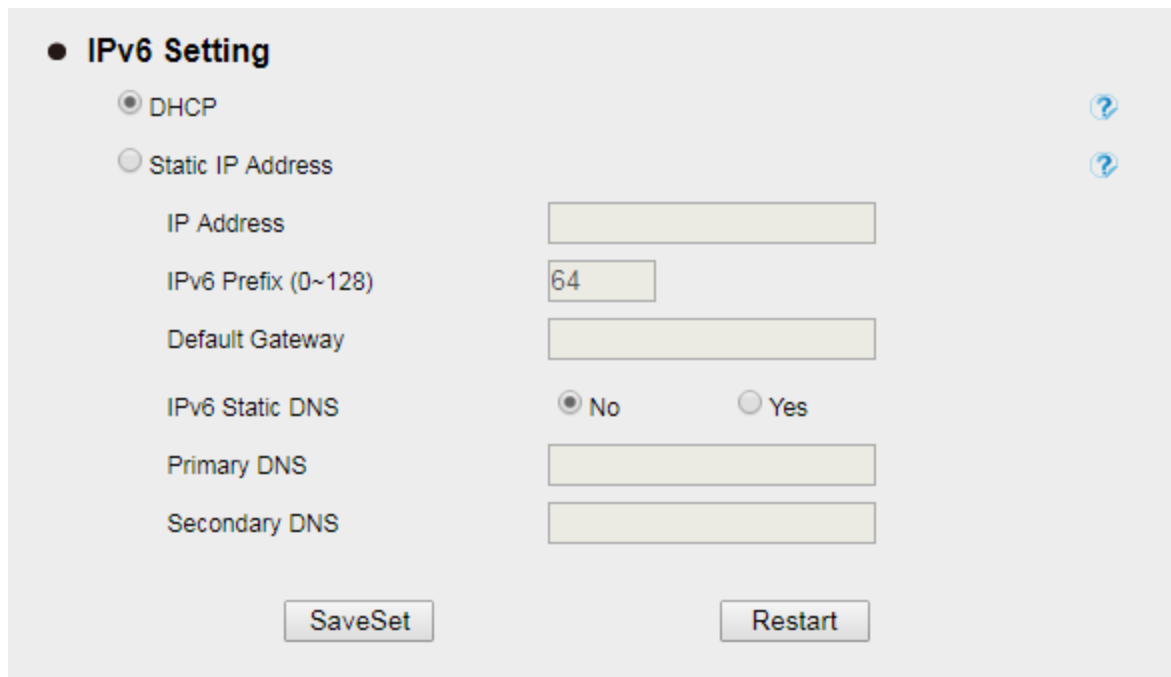

● **IPv6 Setting**

DHCP ?

Static IP Address ?

IP Address

IPv6 Prefix (0~128)

Default Gateway

IPv6 Static DNS No Yes



Primary DNS

Secondary DNS

IPv4&IPv6

If you set IP Mode to IPv4&IPv6, IP phone will support both IPv4 and IPv6 address. The settings of DHCP, Static, and PPPoE are same as above.

To configure IPv4&IPv6 via Phone interface :

1. Press Menu→ Settings→ Advanced Setting (password: admin) → Network→ WAN Port → IP Port Mode.
2. Press  or  to change the IP Port Mode..
3. Press  or Save soft key to save the configuration.

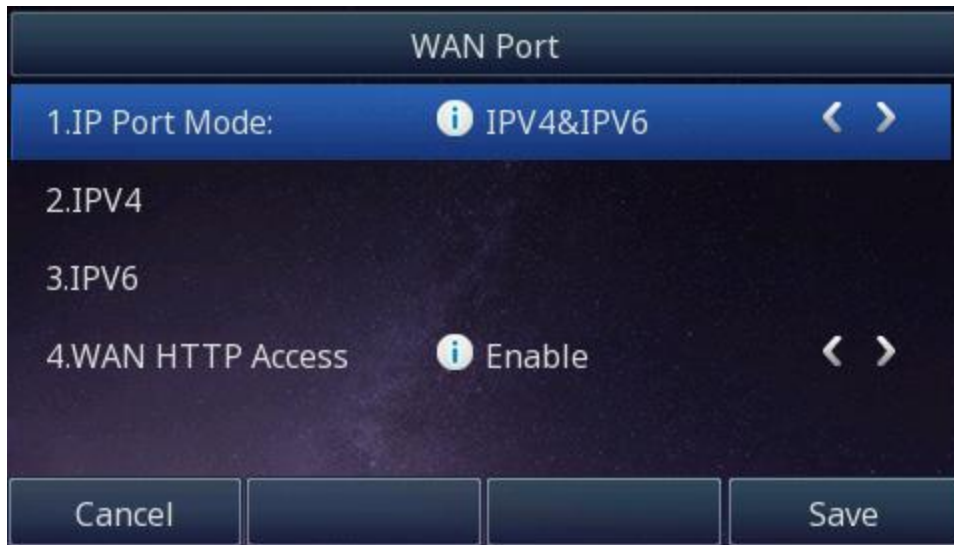

To configure IPv4&IPv6 via Web interface:

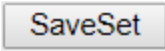
1. Click Network→ Basic→ Internet Port
2. Select IPv4&IPv6 for Internet Port
3. Click  for the setting.

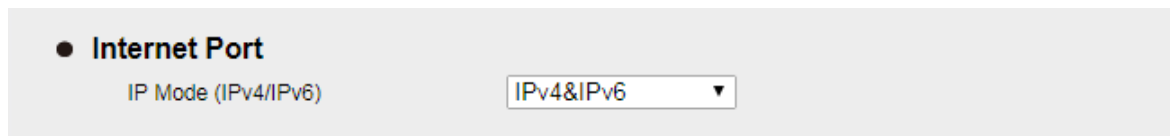

Note:

Wrong network parameters may result in inaccessibility of your phone and may also have an impact on your network performance. For more information about these parameters, contact your system administrator.

PC Port

Three modes for PC port: bridge, connect to Expansion Module and router.

To configure PC Bridge via Phone interface:

1. Press Menu→ Settings→ Advanced Setting (password: admin) → Network→ PC Port → Bridge mode.
2. Click Save

3. Click the OK button, then the phone will reboot.

To configure PC router via Phone interface :

1. Press Menu→ Settings→ Advanced Setting (password: admin) → Network→ PC Port → Router mode.
2. Enter the IP, Netmask and DHCP server
3. Click Save
4. Click the OK button, then the phone will reboot

To configure PC, Connect to Expansion Module via Phone interface :

1. Press Menu→ Settings→ Advanced Setting (password: **admin**) → Network→ PC Port → Connect to Module.
2. Click Save
3. Click the OK button, then the phone will reboot

To configure Bridge via Web interface :

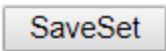
1. Click Network→ PC Port
2. Select As Bridge
3. Click  and the phone will reboot automatically

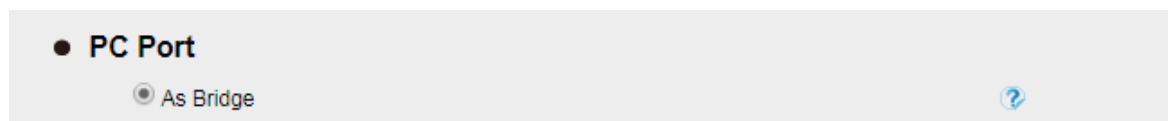
**To configure Router via Web interface :**

1. Click Network→ PC Port
2. Select As Router
3. Fill the IP address and other necessary information.

- Click and the phone will reboot automatically

● PC Port

As Bridge ?

Connect to Expansion Module ?

As Router ?

IP Address

Subnet Mask

IP Lease Time

DHCP Server

DMZ IP

Port Map

Wan port 0	Lan IP	Lan port 0	Protocol	UDP
Wan port 0	Lan IP	Lan port 0	Protocol	UDP
Wan port 0	Lan IP	Lan port 0	Protocol	UDP
Wan port 0	Lan IP	Lan port 0	Protocol	UDP
Wan port 0	Lan IP	Lan port 0	Protocol	UDP
Wan port 0	Lan IP	Lan port 0	Protocol	UDP
Wan port 0	Lan IP	Lan port 0	Protocol	UDP
Wan port 0	Lan IP	Lan port 0	Protocol	UDP

To configure PC, Connect to Expansion Module via Web interface :

- Click Network→ PC Port
- Select as Connect to Expansion Module
- Click and the phone will reboot automatically

● PC Port

As Bridge ?

Connect to Expansion Module ?

As Router ?

IP Address

Subnet Mask

IP Lease Time

DHCP Server

DMZ IP

Contact Setting

This section provides the operating instructions for managing contacts. The topics include:

- Local Directory
- Remote Phonebook
- LDAP
- Search Contact

Local Directory

In the directory, you can add or delete your friends, business partner or anyone others' phone No. so you will not forget their number. Or put some anonymous phone No. in the blacklist to prevent from being disturbed. The local Directory can add up to 1000 contacts.





A. To add contacts list into local directory

To add contacts manually via Phone interface

1. Press Menu → Directory → Local Contacts
2. Press Add soft key.
3. Enter the necessary information as Name, Phone number...
4. Press save soft key or  to add the contacts successfully.



To add contacts from history via Phone interface :

1. Press History soft key or press Menu → History → Local History
2. Press  and  to select the targeted one. (Press  and  switched among the All calls, Dialed calls, Received calls, Missed Calls and Forward Calls).
3. Press Option soft key → Add to Contacts
4. Edit the necessary information as Name, Phone number...
5. Press save soft key or  to add the contacts successfully.

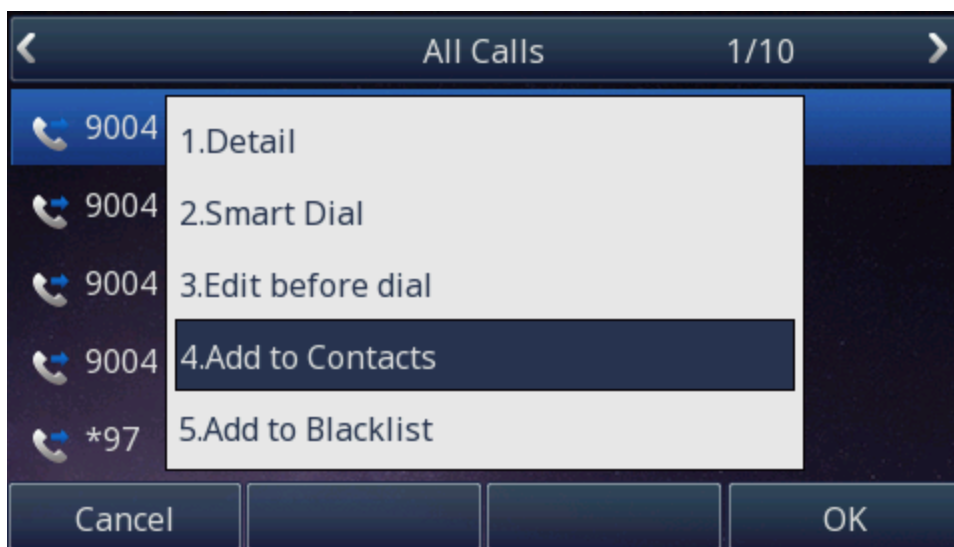

To add contacts via Web interface :

1. Click Directory→ Directory
2. Enter the name, number and some other information.
3. Press and then press button.



B: To add contacts into blacklist

To add blacklist manually via Phone interface :

1. Press Menu → Directory → BlackList
2. Press Group soft key.
3. Press Add soft key.
4. Enter the Name and select the Ring Tone.
5. Press Save soft key or to add the Group successfully.

6. Enter the added Group, then press Add soft key.
7. Enter the necessary information as Name, Phone number...
8. Press Save soft key or  to add the contacts successfully.

To add blacklist from history via Phone interface:

1. Press History soft key or press Menu → History → Local History
2. Press  and  to select the targeted one.
3. Press Option soft key → Add to Blacklist
4. Edit the necessary information as Name, Phone number...
5. Press save soft key or  to add successfully.

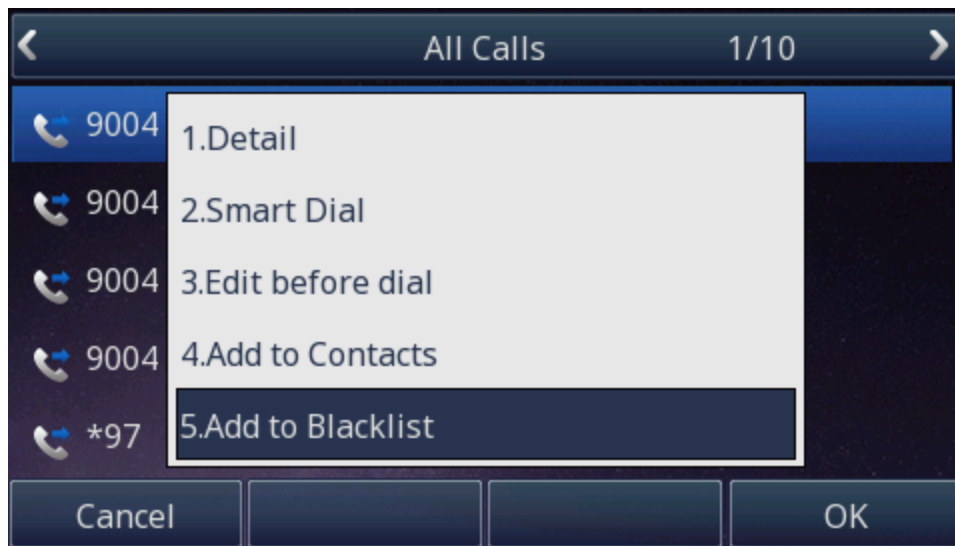

Upload Contacts photo via Web interface:

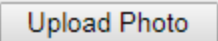
1. Click Directory and select the desired contact.
2. Click Choose file to select the photo for the contact
3. Click  to upload the photo.

Htek

[Home](#) | [Profile](#) | [Account](#) | [Network](#) | [Function Keys](#) | [Setting](#) | [Directory](#) | [Management](#)

Directory

Remote Phone Book

Call History

LDAP

Network Directory

MultiCast Paging

Contact
BlackList
Hangup

Index	Display Name	Office Number	Mobile Number	Other Number	Account	
1	Luisa	860			Auto	<input checked="" type="checkbox"/>

Save Delete Move to Contact/blacklist

Contact

Name:

Office Number:

Mobile Number:

Other Number:

Account:

Ring:

Group:

Photo:

GroupInfo

Group:

Ring:

No file chosen

Import Local Contacts

No file chosen

No file chosen

Show Title

NOTE

Add Contact/Blacklist
Fill in the contact information and the contact name can not be empty.

Delete Contact/Blacklist
Select a contact or more contacts and press the button 'Delete' to delete it.

Move to Contact/blacklist
Select a contact or more contacts and press the button 'move to Contact/Blacklist' to move it.

Upload Photo
The format of the photo supported is jpg or bmp, and the size should be less than 128 *128

Import
Browse .xml and .csv format's file and import.

Export
Click Export button, then the phonebook.xml or phonebook.csv file will be downloaded.

When you place a call from the contact, the phone idle screen will show the contact photo.

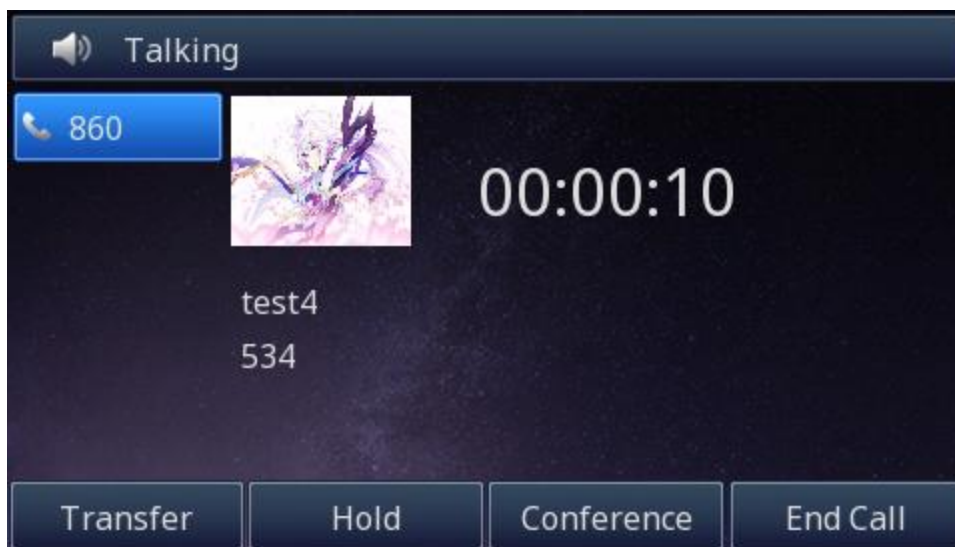

Note:

The format of the photo supported is jpg or bmp

Photo size should be less than 2MB, name length should be less than 48 characters.

To import or export the contact list

You can manage your phone's local directory via phone or web user interface. But you can only import or export the contact list via Web interface.

To import an XML file of contact list via Web interface:

1. Click on Directory → Directory
2. Click Choose file to select a contact list file (file format must be .xml) from your local system.
3. Click Import XML to import the contact list.

To export an XML file of contact list via Web interface:

1. Click on Directory → Directory
2. Click Export XML to import the contact list.

To import a CSV file of contact list via Web interface:

1. Click on Directory → Directory
2. Click Choose file to select a contact list file (file format must be .csv) from your local system.
3. Click Import Csv to import the contact list.

To export a CSV file of contact list via Web interface:

1. Click on Directory → Directory
2. Click Export Csv to import the contact list.

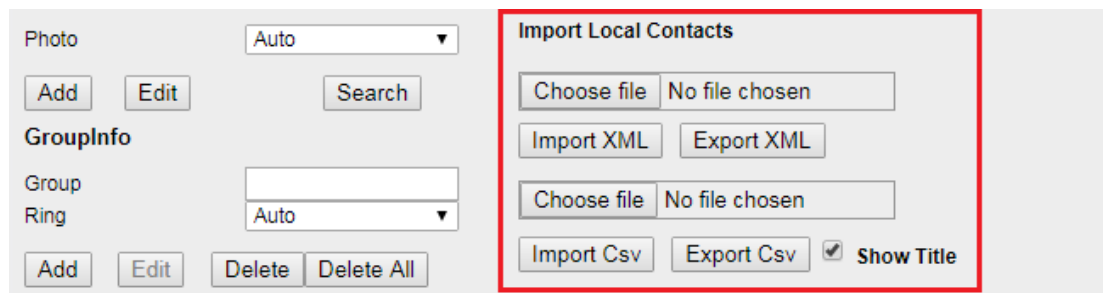

Note:

If the xml file and CSV file more than 1000 contacts, the phone will only upload 1000 contacts.

Remote Phonebook

To set Remote Phonebook via Web interface:

1. Login the webpage and click Directory→ Remote Phone Book
2. Fill the path of the remote file in the Phone Book URL field.
For example,
`http://192.168.0.106/Phonebook/Remote_Phonebook/remotephonebook.xml`
3. Fill the Name and then click to save the configuration.

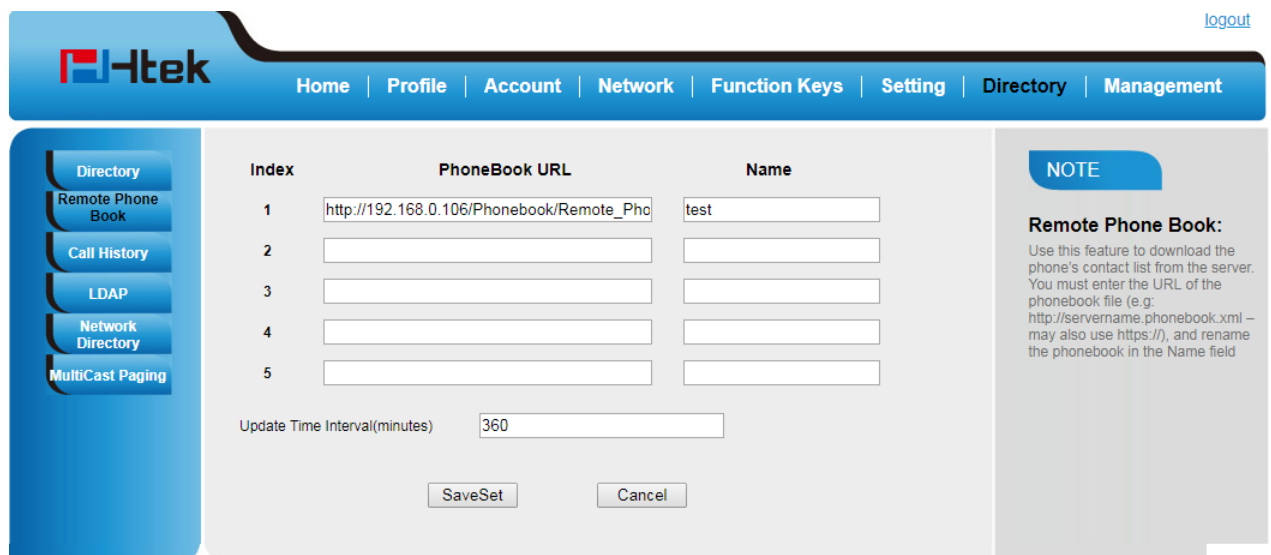

To check the contacts via Phone interface:

Press Directory→ Left Button→ Left Button, and then you can see the item you set, press enter you will find the detail.

For More detail, please refer to: [Remote Phonebook](http://www.htek.com) on www.htek.com .

Note:

Every remote contact, only supports 1000 contacts.

LDAP Phonebook

When use the LDAP feature, you can get the LDAP Phonebook directly.

To configure LDAP via Web interface:

1. Login webpage and click Directory→ LDAP
2. Filled the LDAP Name Filter:
 - a) This parameter specifies the name attributes for LDAP searching. The “%” symbol in the filter stands for the entering string used as the prefix of the filter condition.
 - b) For example, (cn=%), when the name prefix of the cn of the contact record matches the search criteria, the record will be displayed on the IP PHONE LCD.
3. Filled LDAP Number Filter:
This parameter specifies the number attributes for LDAP searching.
4. Filled Server Address: Fill the domain name or IP address of the LDAP Server.
For example: 192.168.0.9
5. Port (the port of the LDAP Serve) Base, User Name, Password
6. Max.Hits(1-32000): the maximum number of the search results to be returned by the LDAP server.
7. LDAP Display Name: the display name of the contact record displayed on the LCD screen.
8. Filled the relative value and then click  to save the settings.

Following is the example screenshot for the configuration.

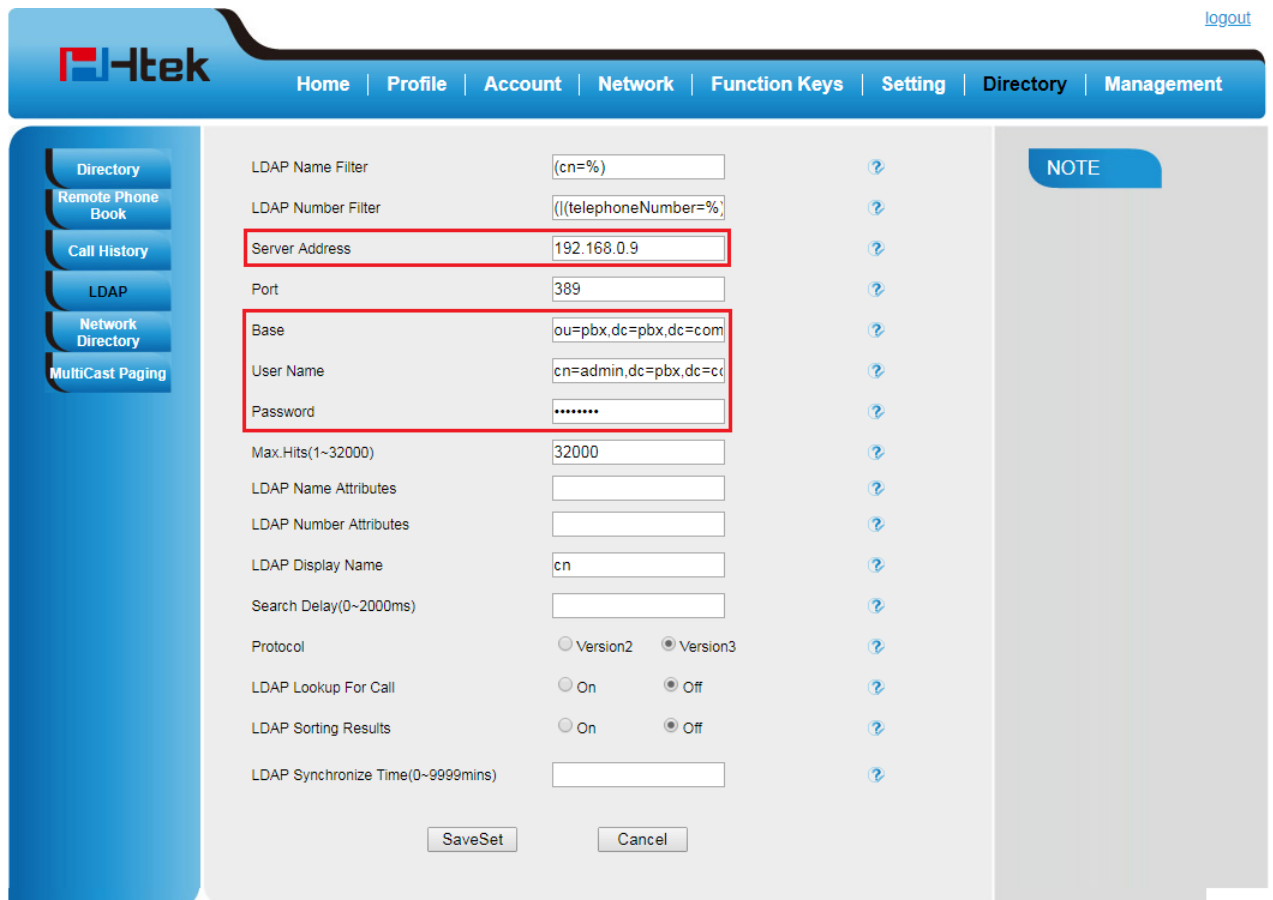

To Configure LDAP Key

To configure LDAP Key via Web interface :

1. Click Function Key→ Line Key→ choose Line Key 2(for example)
2. Select LDAP in the Type field.
3. Click SaveSet to save the configuration.

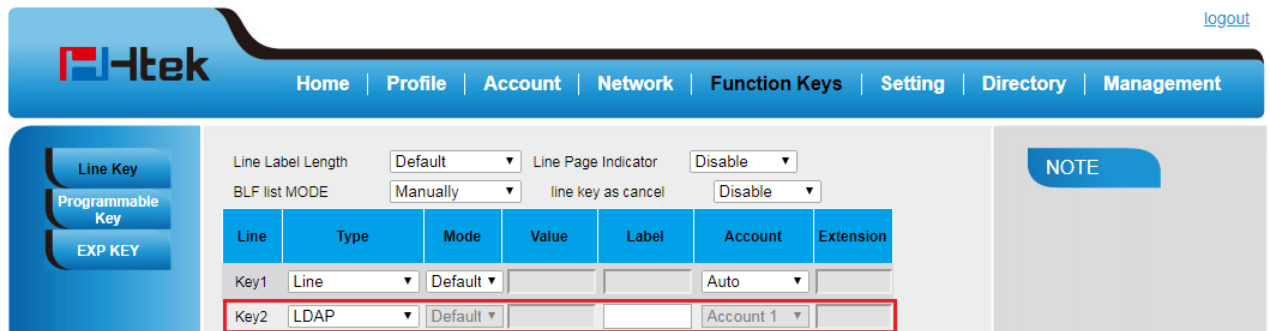

To Configure LDAP Key via Phone interface :

1. Press Menu→ Features→ Function Keys→ Line Keys as Function Keys→ Line Key 2
2. Select LDAP in the Type field
3. Press Save or OK key to save the configuration.

When press the LDAP Key the LCD will display as following:



For More detail, please refer to [LDAP Notes](http://www.h-tek.com) on www.h-tek.com

Search Contact

You can search contact in all contacts, local contacts, remote contacts and LDAP contact.

To search contact in all contacts:

1. Click the Directory soft key on Idle interface.
2. Click the More soft key, then you can see the Search soft key
3. Click the Search soft key, you can enter the desired part of name or part of number.
4. With the search content to match the contact will be automatically displayed on the LCD within 5 seconds.

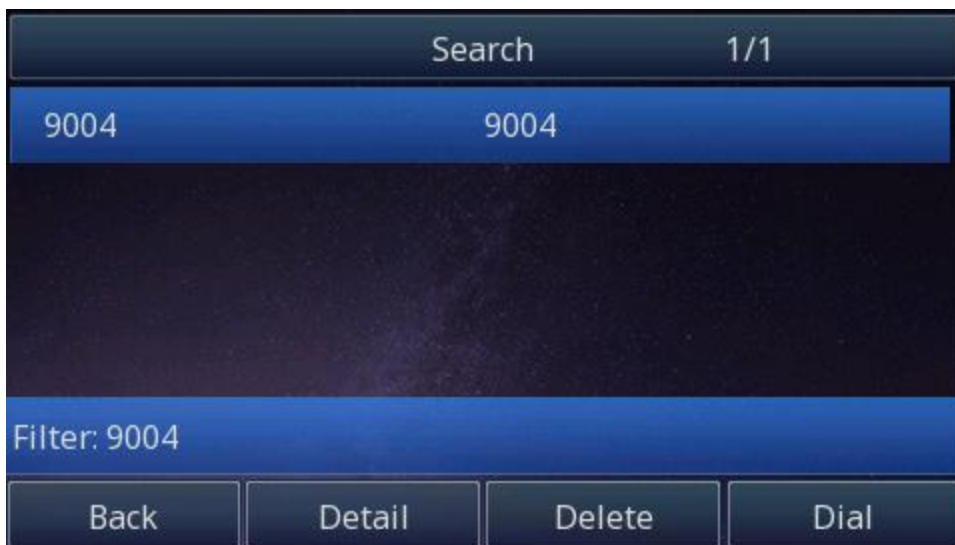
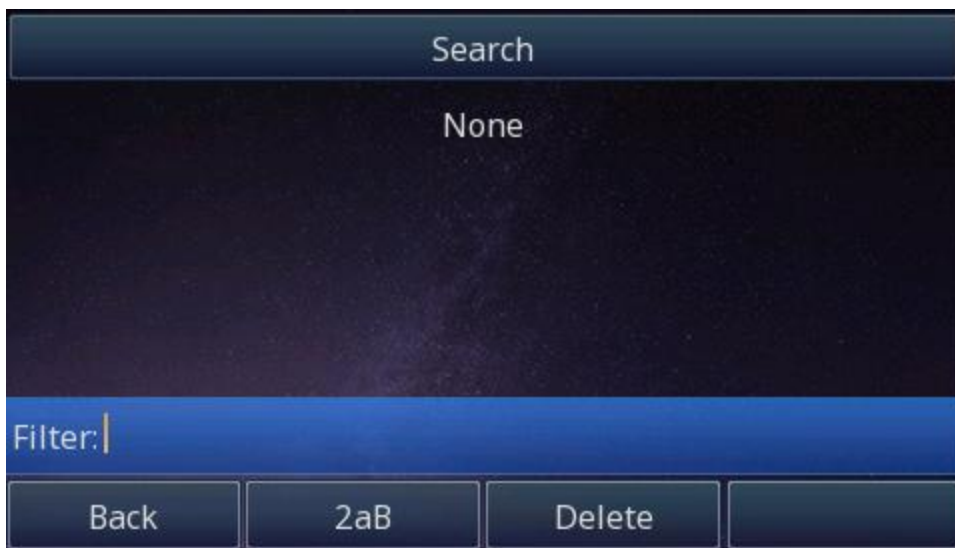

To search contact in Local contacts:

1. Click the Directory soft key on Idle interface.
2. Click the  button and select the Local contacts list.

3. Click the More soft key, then you can see the Search soft key
4. Click the Search soft key, you can enter the desired part of name or part of number.
5. With the search content to match the contact will be automatically displayed on the LCD within 5 seconds.

To search contact in Remote contacts:

1. Click the Directory soft key on Idle interface.
2. Click the  button and select the remote contacts list.
3. Select the desired remote contact and click Enter soft key.
4. Click the Search soft key, you can enter the desired part of name or part of number.
5. With the search content to match the contact will be automatically displayed on the LCD within 5 seconds.

To search contact in LDAP contacts:

1. Click the LDAP function key.
2. Click the  button and select the LDAP Contacts list.
3. Enter the first character or more of contact's name or number.
4. With the search content to match the contact will be automatically displayed on the LCD within 5 seconds.



Call History Setting

Call History

This phone maintains call history lists of Dialed Calls, Received Calls, Missed Calls and Forwarded Calls. The call history list supports up to 100 entries in all on phone interface and more than 1500 items. You can check the call history, dial a call, add a contact or delete an entry from the call history list. You should enable the history record feature in advance.

To enable the history record feature via Phone interface:

1. Press Menu→ Features→ History Setting

2. Press  and  or Switch soft key to enable History record.
3. Press Save soft key to save the configuration.

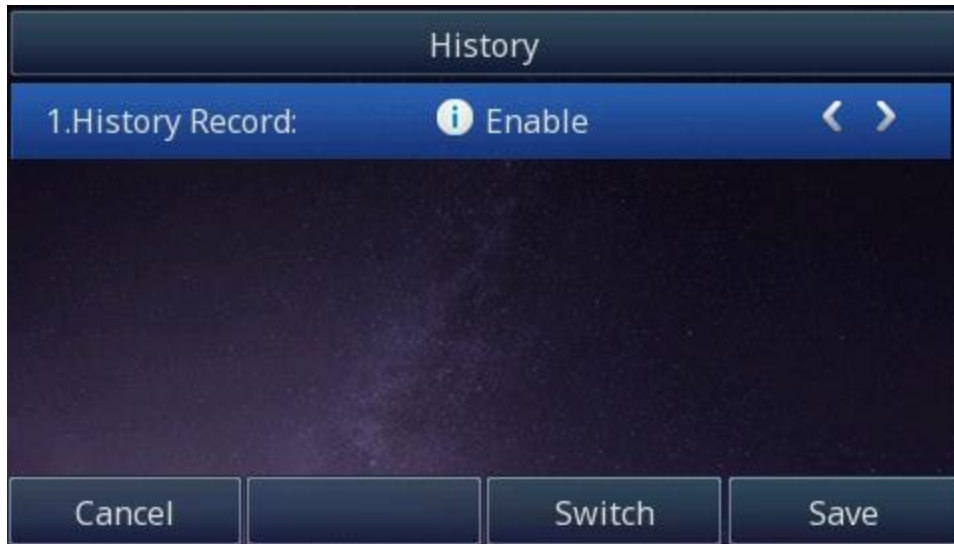

To check the call history via Phone interface :

1. Press the History soft key. The LCD screen displays All Calls list.
2. Press Right or Left Key to switch among All Calls, Missed Calls, Received Calls, Dialed Calls and Forwarded Calls.
3. Press to select the desired entry.
4. Press the Option soft key, and then select Detail from the prompt list.
5. The detailed information of the entry appears on the LCD screen.

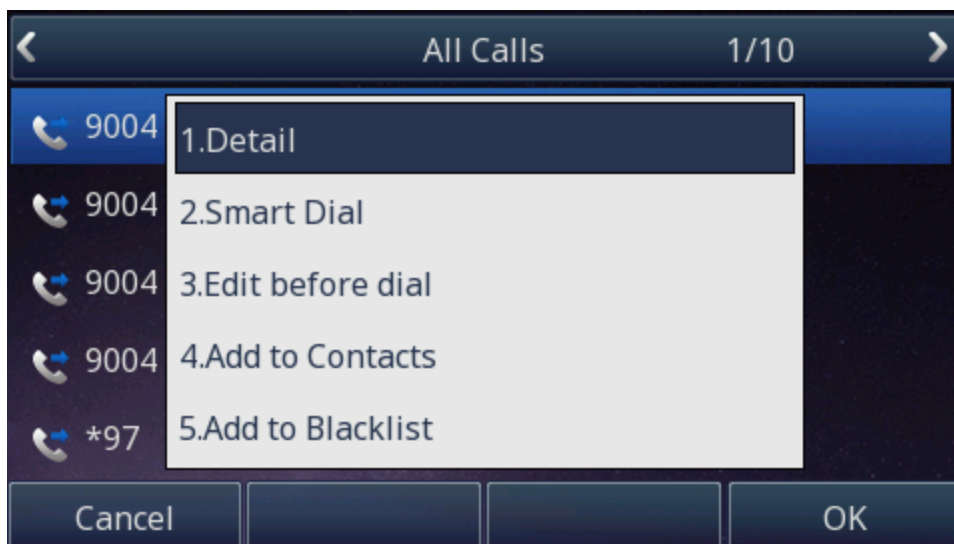

To delete an entry from the call history list via Phone interface :

1. Press the History soft key.
2. Press Right or Left Key to switch among All Calls, Missed Calls, Received Calls, Dialed Calls and Forwarded Calls.
3. Press UP or DOWN key to select the desired entry.
4. Press the Delete soft key.

To delete all entries from the call history list via Phone interface :

1. Press the History soft key.
2. Press Right or Left Key to switch among All Calls, Missed Calls, Received Calls, Dialed Calls and Forwarded Calls.
3. Press the Option soft key, and then select Delete All from the prompt list.
4. Press the OK soft key.
5. Press the OK soft key to confirm the deleting or the Cancel soft key to cancel.

To check the call history via Web interface :

1. Click Directory→ Call History
2. Click Dialed List, Missed List, Received List, Forwarded List then you can see the history list.

logout

Home | Profile | Account | Network | Function Keys | Setting | Directory | Management

Directory

Remote Phone Book

Call History

LDAP

Network Directory

MultiCast Paging

Dialed List		Missed List		Received List		Forwarded List	
Index	Date	Time	Local Identity	Name	Tel Number		
1	07-03-2018	20:42:36		533	533		
2	07-03-2018	20:42:32		860	860		
3	07-03-2018	01:03:55		532	532		

Export XML | Export Csv

NOTE

To Dial a call from Call History via Web interface :

1. Click Directory→ Call History
2. Select the desired history item, and click Tel Number.
3. Then the call is dialed on phone.

[logout](#)

Home | Profile | Account | Network | Function Keys | Setting | Directory | Management





Directory
Remote Phone Book
Call History
LDAP
Network Directory
MultiCast Paging

Dialled List					
Index	Date	Time	Local Identity	Name	Tel Number
1	07-03-2018	20:42:36		533	533
2	07-03-2018	20:42:32		860	860
3	07-03-2018	01:03:55		532	532

Export XML | Export Csv

NOTE

To Dial a call from Call History via Phone interface :



1. Press History soft key or press Menu → History → Local History
2. Press  and  to select the targeted one.
3. Press the Send soft key, , or , or the corresponding line key.

Audio Setting

Ring Tone

You can adjust the type and volume of the ring tone.

To adjust the Ring Tone Type via Phone interface :



1. Press Menu → Settings → Basic Settings → Ring Tone.
2. Press  and  to select the aimed one.
3. Press  or Save soft key to save the configuration.

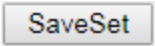

To adjust the Ring Tone Type via Web interface



1. Setting → Preference → Ring Tone
2. Select the wanted one
3. Click  to save the configuration.

To configure Distinctive Ring Tone via Phone interface

1. Press Directory
2. Select the target contact
3. Press Detail soft key to edit the contact.
4. Press  and  to select the wanted Ring Tone for the contact
5. Press Save soft key to save the contact.



To configure Distinctive Ring Tone via Web interface

1. Directory → Directory → Contact
2. Choose the Ring Tone you want to use.
3. Click  →  to save the configuration.

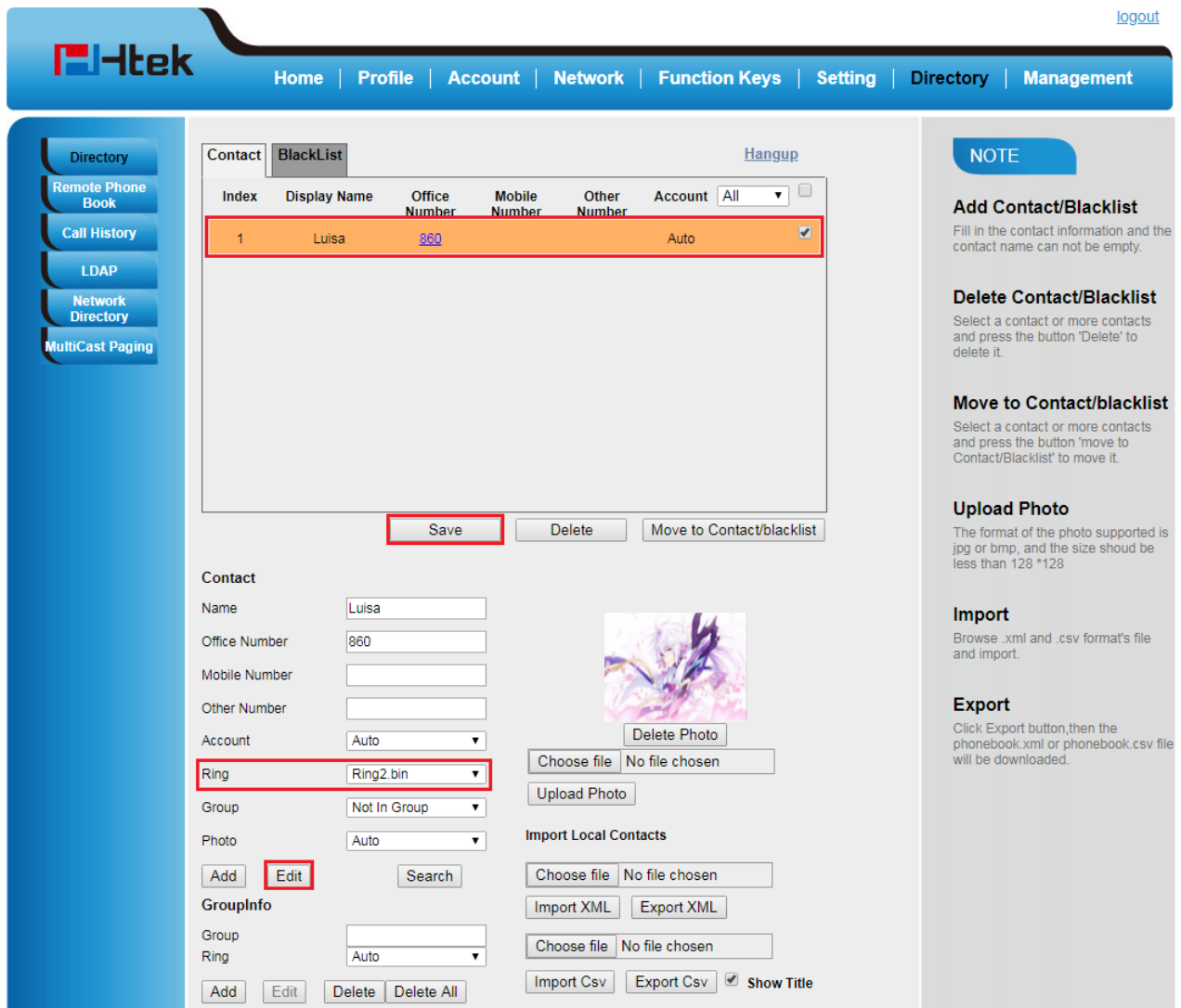

The screenshot shows the Htek web interface with the following elements:

- Header:** Htek logo and navigation menu (Home, Profile, Account, Network, Function Keys, Setting, Directory, Management).
- Left Sidebar:** Directory, Remote Phone Book, Call History, LDAP, Network Directory, MultiCast Paging.
- Main Content:**
 - Contact List:** A table with columns: Index, Display Name, Office Number, Mobile Number, Other Number, Account. One contact is listed: Index 1, Display Name Luisa, Office Number 860, Account Auto. The 'Save' button below the table is highlighted.
 - Contact Form:** Fields for Name (Luisa), Office Number (860), Mobile Number, Other Number, Account (Auto), Ring (Ring2.bin), Group (Not In Group), Photo (Auto). The 'Ring' dropdown and 'Edit' button are highlighted.
 - Buttons:** Add, Edit, Search, Delete, Delete All.
 - Import Local Contacts:** Choose file, No file chosen, Import XML, Export XML, Import Csv, Export Csv, Show Title.
- Right Sidebar (NOTE):** Add Contact/Blacklist, Delete Contact/Blacklist, Move to Contact/blacklist, Upload Photo, Import, Export.

Click [Ring tone](#) for more information.

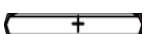

Volume

You can adjust the volume for the phone by the volume keys:  and .

To adjust the Ring tone volume via Phone interface :

- Option 1: To press  and  on the idle page



- Option 2: To press  and  during the call is ringing.

To adjust the handset volume via Phone interface:

To press  and  during a call in handset mode.

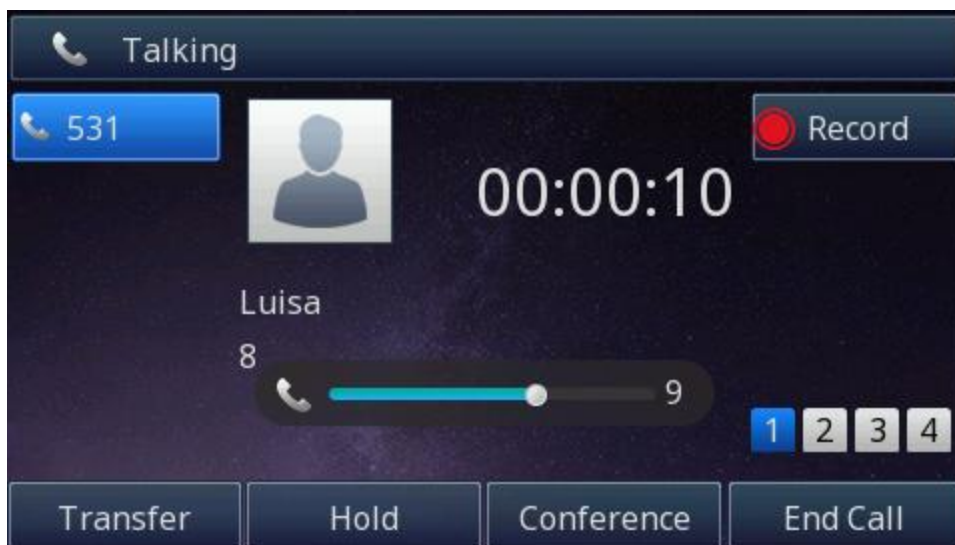

To adjust the headset volume via Phone interface:

To press  and  during a call in headset mode.

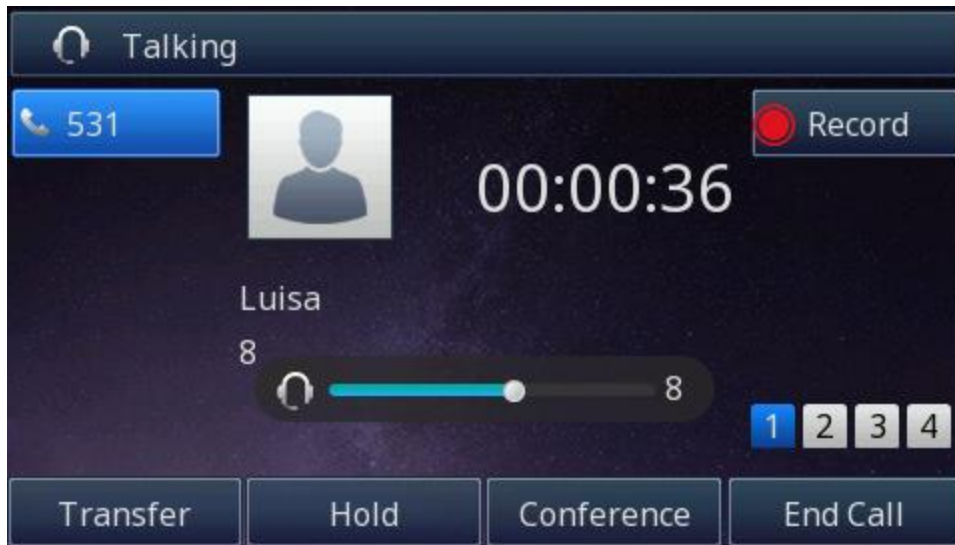

To adjust the speaker Volume via Phone interface:

To press  and  during a call in speaker mode.

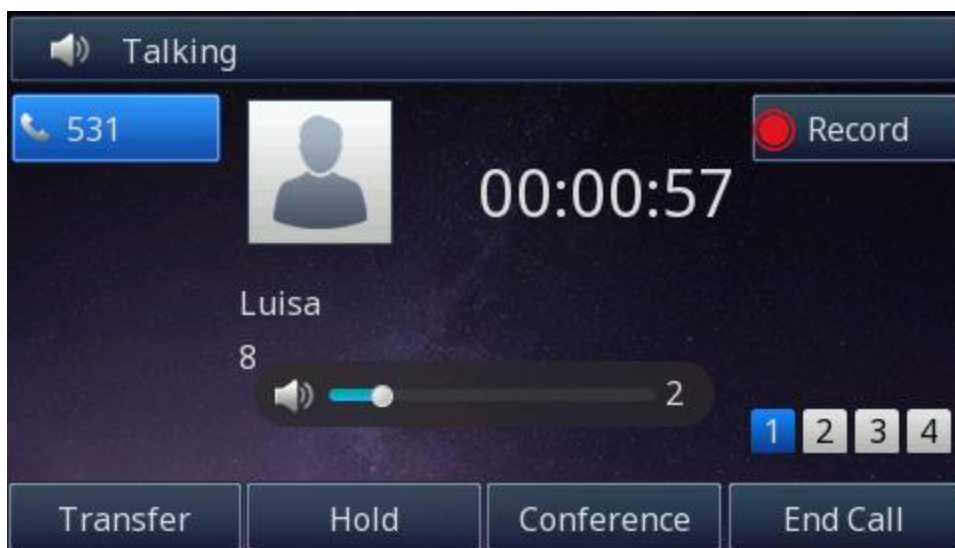

Voice Mail Tone

This option can set whether to play the beep for phone's voice mail

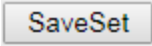
1. Click the Setting → Preference
2. Select On or Off for Voice Mail Tone.
3. Click  for the setting.

Voice Mail Tone On Off

Play Hold Tone

When you hold the phone, Whether to play hold tone

1. Click the Setting → Preference
2. Set On or Off for Play Hold Tone.
3. Click for the setting.

Play Hold Tone On Off

Play Hold Tone Delay

When you hold the phone. How many seconds to play beep?

1. Click the Setting → Preference
2. Set the value for Play Hold Tone Delay.
3. Click for the setting.

Play Hold Tone Delay

System Settings

Dial Plan

Dial plan is a string of characters that governs the way this phone processes the inputs received from your phone keypad. This phone supports dial plan with following accept digits:

1,2,3,4,5,6,7,8,9,0, *, #

Grammar	Description
x	any digit from 0-9;
xx+	at least 2-digit number;

^	exclude;
,	hear dial tone;
[3-5]	any digit of 3, 4, or 5;
[147]	any digit 1, 4, or 7;
<2=011>	replace digit 2 with 011 when dialing.

To configure dial plan via Web interface:

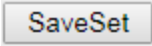
1. Click Account—Advanced—Dial Plan.
2. Filled the value in dial plan field.
3. Click  to save the configuration.

[logout](#)

Htek

[Home](#) | [Profile](#) | [Account](#) | [Network](#) | [Function Keys](#) | [Setting](#) | [Directory](#) | [Management](#)

Basic

Account

Account Status Registered

* Account Active No Yes

Profile Profile 1

Label

* SIP User ID

* Authenticate ID

* Authenticate Password

Name

Local SIP Port

Use Random Port No Yes

Voice Mail UserID

Dial Plan

Eventlist BLF URL

Shared Line

SCA Barge-In

Direct Call Pickup Code

Group Call Pickup Code

Feature Key Sync

Account 1

Profile 1

533

533

5060

No Yes

[[[*]*+}

Disable

Disable

*04

Disable

NOTE

The * fields must be filled (requires a phone restart)

Basic:
The Basic parameters configured by the administrator.

SaveSet Restart

Note:

Illegal input will fall back to default: `{{[*]*+}`. For More, please refer to [dial plan](#) on www.htek.com

Dial-Now Timeout

Dial-Now Timeout means that when you enter the number which is matching with dial plan, it will dial out automatically after some time when you stop entering the number.

To configure Dial-Now Timeout via Web interface :

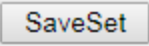
1. Click Webpage Setting → Preference
2. Fill the blank of Dial-Now Timeout: for example, 5(seconds). (0 means dial out immediately).
3. Click the  button to save the configuration

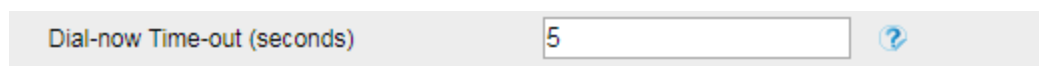

Dial-now Time-out (seconds) 

No Key Entry Timeout

No Key Entry Timeout means that when you enter the number, it will dial out automatically after some time when you stop enter the number.

To configure No Key Entry Timeout via Web interface :

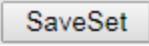
1. Click Webpage Setting → Preference
2. Fill the blank of No Key Entry Timeout: for example, 5(seconds). (0 means never timeout), you should press the send key the dial out the number.
3. Click the  button to save the configuration.

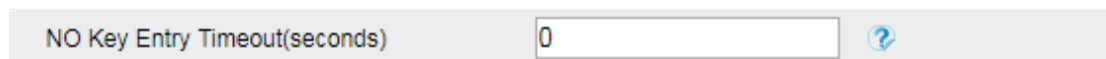

NO Key Entry Timeout(seconds) 

Emergency Call

Public telephone networks in countries around the world have a single emergency telephone number (emergency services number), that allows a caller to contact local emergency services for assistance when required. The emergency telephone number may differ from country to country. It is typically a three-digit number that can be easily remembered and dialed quickly. Some countries have a different emergency number for each of the different emergency services.

You can specify the emergency telephone numbers on the IP phone for contacting the

emergency services in an emergency situation.

To configure emergency call via Web interface:

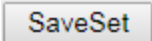
1. Click Setting→ Features→ Phone Lock
2. Enter the emergency services number (e.g.110,119,120) in the Emergency field,
3. Click  to save the configuration.

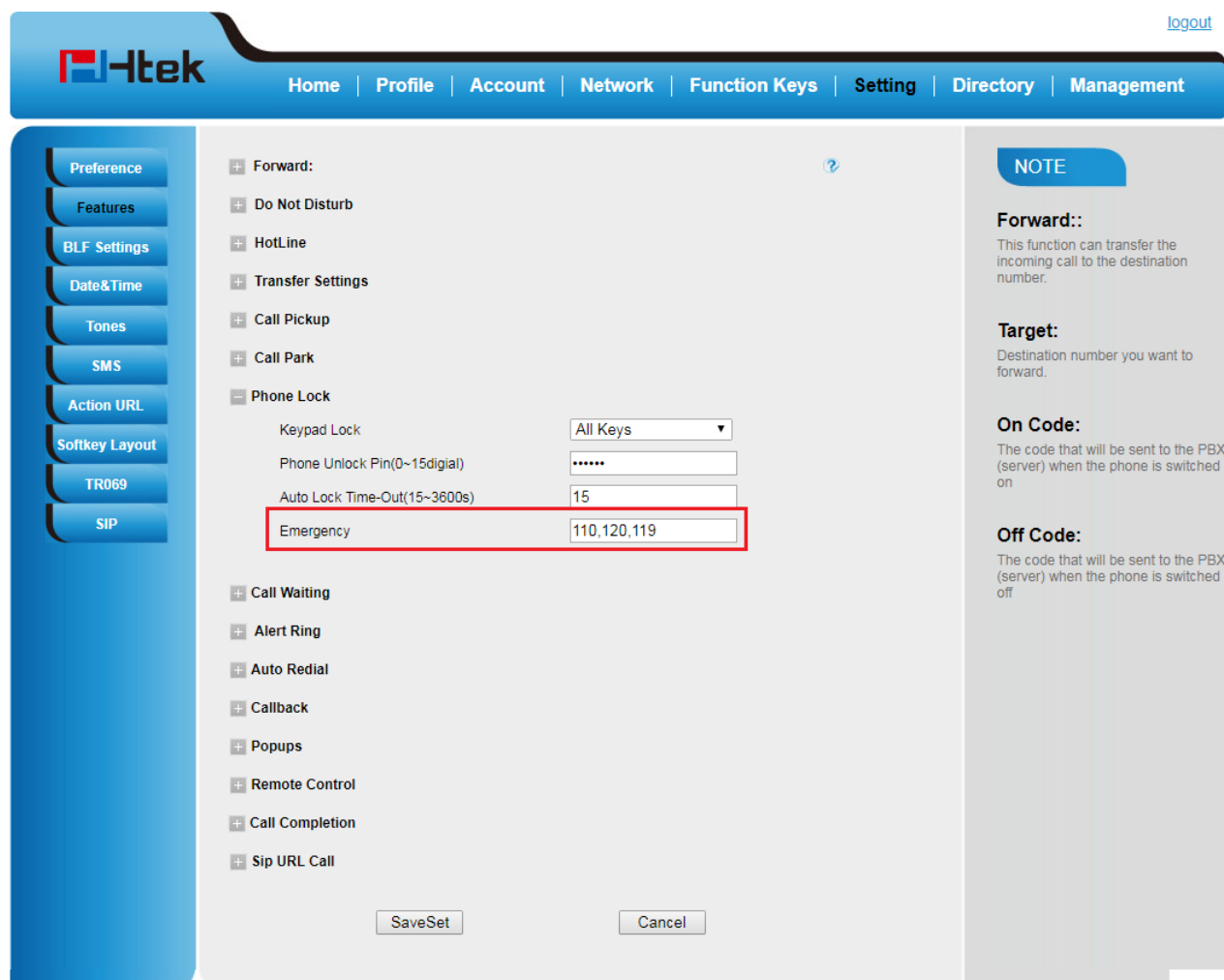

The screenshot shows the Htek web interface for configuring settings. The top navigation bar includes Home, Profile, Account, Network, Function Keys, Setting, Directory, and Management. The left sidebar lists various settings categories: Preference, Features, BLF Settings, Date&Time, Tones, SMS, Action URL, Softkey Layout, TR069, and SIP. The main content area displays the 'Phone Lock' configuration page. The 'Emergency' field is highlighted with a red box and contains the value '110,120,119'. Other fields include Keypad Lock (All Keys), Phone Unlock Pin (0~15digital), and Auto Lock Time-Out (15~3600s). The 'NOTE' section on the right provides information about Forward, Target, On Code, and Off Code settings.

Label Scroll

When setting function keys, you need to set the label of the function keys. If the words are too long to show on the label, you can use this function to make labels scroll. Another approach is to set the labels to long label mode.

To configure Label Scroll via Web interface:

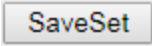
1. Click the Setting → Preference
2. Select Enable or Disable for Label Scroll.
3. Click  for the setting.

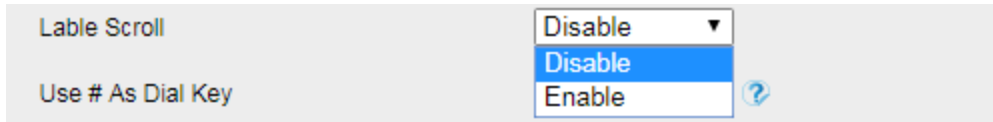

Show Missed Calls

Whether to show missed call notification on LCD

To configure Show Missed Calls via Web interface :

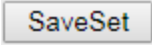
1. Click the Setting → Preference
2. Select Yes or No for Show Missed Calls.
3. Click  for the setting.



Auto Logout Time

Set the Web login timeout

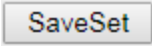
1. Click the Setting → Preference
2. Set number 1~5000 min for Auto Logout Time.
3. Click  for the setting.

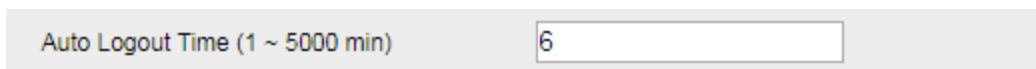

Reboot in Talking

This function is to allow reboot during the calls or not

1. Click the Setting → Preference
2. Set Enable or Disable for Reboot in Talking.

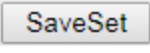
3. Click  for the setting.

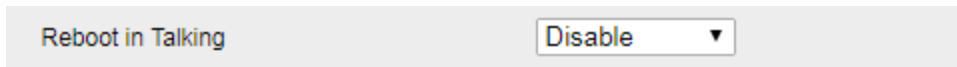

Detect IP Conflict

LCD can display message when IP conflict

1. Click the Setting → Preference
2. Set Enable or Disable for Detect IP Conflict.

3. Click  for the setting.

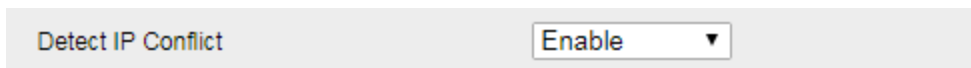

Redial Mode

Call redial has two ways:(1) To redial the last placed call from the IP Phone (2) To redial the call from all calls list

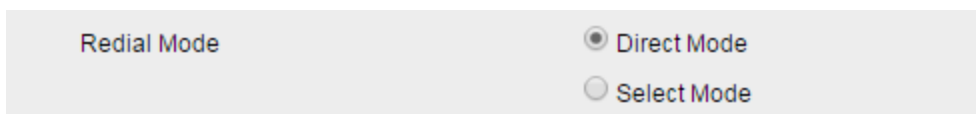

1. Click the Setting → Preference
2. Set Direct Mode or Select Mode for Redial Mode.

3. Click  for the setting.





Keypad Lock

To enable Keypad Lock via Phone interface

1. Press Menu--Settings--Advanced Setting--Phone Setting--Lock
2. Press  and  key or Switch to change selected lock type: All Keys, Menu Key, Function Key, Lock & Answer

3. Press Save or OK key to save the configuration.

To disable Keypad Lock via Phone interface

1. Press Menu--Settings--Advanced Setting--Phone Setting--Lock
2. Press  and  key or Switch to change to choose Disable.
3. Press Save or OK key to save the configuration.

To enable Keypad Lock via Webpage

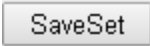
1. Click Webpage Setting → Features
2. To choose the Phone Lock.
3. To fill the Phone Unlock Pin and Auto Lock Time-Out
4. Fill the Emergence Number, when the phone is Lock, only Emergency Number can be sent.
5. To click  to save the configuration.

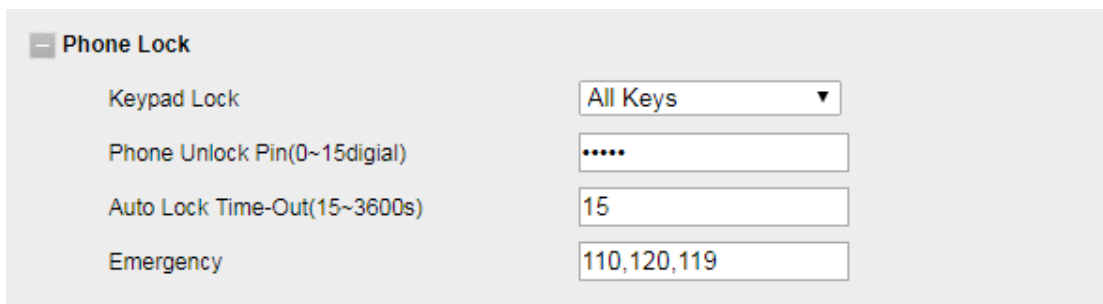

The screenshot shows a configuration page titled "Phone Lock" with a minus sign icon on the left. It contains four rows of settings:

Keypad Lock	All Keys
Phone Unlock Pin(0~15digial)
Auto Lock Time-Out(15~3600s)	15
Emergency	110,120,119

To Disable Keypad Lock via Webpage

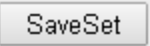
1. Click Webpage Setting →Features
2. To choose Disable for the Phone Lock.
3. To click  to save the configuration.

Suppress DTMF Display

In order to ensure safety in Call process, you can choose whether to hide DTMF

1. Click the Setting → Preference
2. Select On or Off for Suppress DTMF Display.

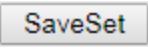
3. Click  for the setting.

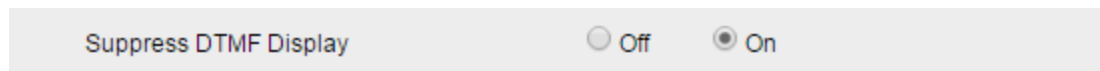

Suppress DTMF Display Delay

In order to ensure safety in Call process, you can choose whether to hide DTMF

1. Click the Setting → Preference
2. Select On or Off for Suppress DTMF Display Delay.

3. Click  for the setting.

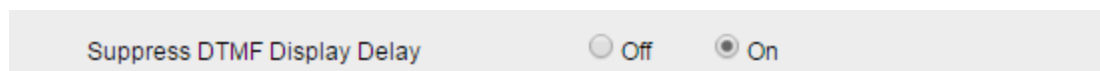

Check-Syn With Authenticate

If this option is enabled, the server needs to be authenticated before the phone agrees to synchronize.

1. Click the Setting → Preference
2. Set Enable or Disable for Check-Syn With Authenticate.

3. Click  for the setting.

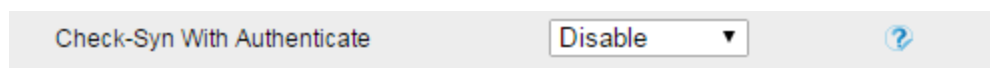

Other features settings

Action URL

To configure action URL via Web interface :

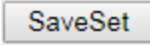
1. Click Setting→ Action URL
2. Fill the needed values in the designated blank spaces.
3. Click  to save the setting.

Click [Action URL](#) for more how to use, or check on www.htek.com

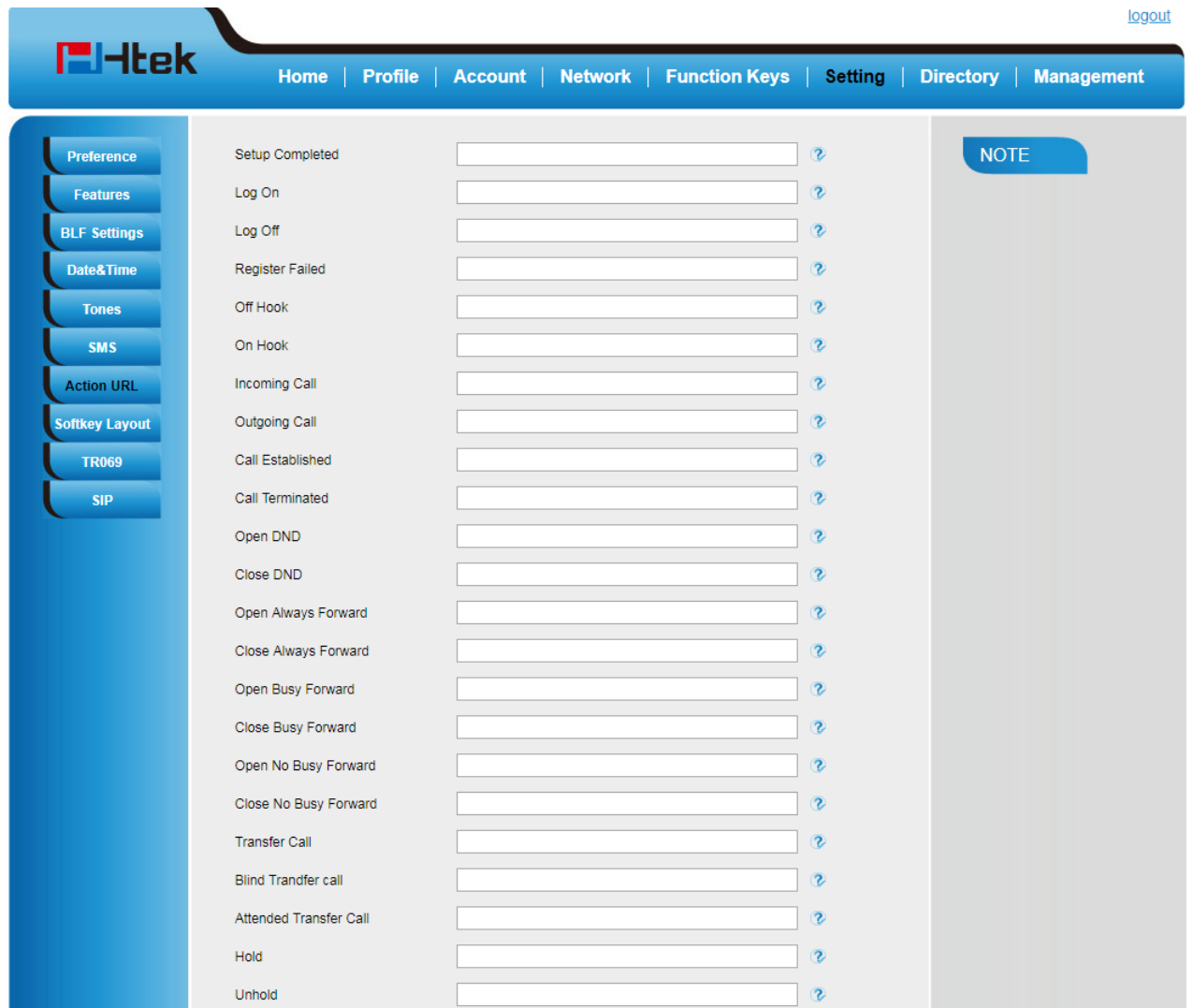





Label	Input Field	Help Icon
Setup Completed	<input type="text"/>	?
Log On	<input type="text"/>	?
Log Off	<input type="text"/>	?
Register Failed	<input type="text"/>	?
Off Hook	<input type="text"/>	?
On Hook	<input type="text"/>	?
Incoming Call	<input type="text"/>	?
Outgoing Call	<input type="text"/>	?
Call Established	<input type="text"/>	?
Call Terminated	<input type="text"/>	?
Open DND	<input type="text"/>	?
Close DND	<input type="text"/>	?
Open Always Forward	<input type="text"/>	?
Close Always Forward	<input type="text"/>	?
Open Busy Forward	<input type="text"/>	?
Close Busy Forward	<input type="text"/>	?
Open No Busy Forward	<input type="text"/>	?
Close No Busy Forward	<input type="text"/>	?
Transfer Call	<input type="text"/>	?
Blind Transfer call	<input type="text"/>	?
Attended Transfer Call	<input type="text"/>	?
Hold	<input type="text"/>	?
Unhold	<input type="text"/>	?

Softkey Layout

This feature mainly defines which shown on the soft key in some status. For example, what the soft key displays when dialing, or talking.

To configure Soft key via Web interface:

1. Click Setting → Softkey Layout
2. Select Enable for Custom Softkey
3. Select call States.
4. Select the feature from the Disable Keys to Enable Keys field by 

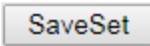
 moves the Disable key to Enable field.  moves the Enable key, and it will back to Disable field.
4. Click  or  to change to position or each feature.
5. Click  to save the configuration.

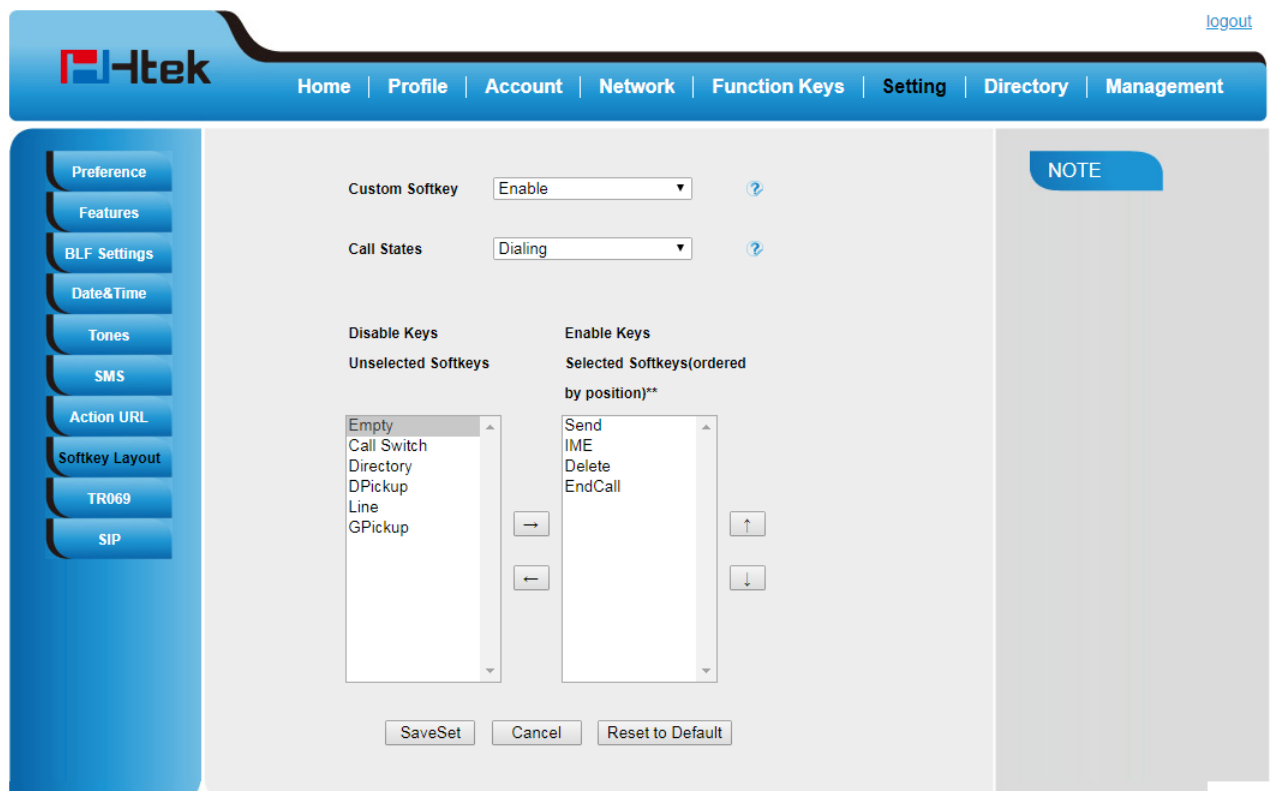

The screenshot shows the Htek web interface for configuring Softkey Layout. The top navigation bar includes Home, Profile, Account, Network, Function Keys, Setting, Directory, and Management. A sidebar on the left lists various settings: Preference, Features, BLF Settings, Date&Time, Tones, SMS, Action URL, Softkey Layout (selected), TR069, and SIP. The main content area is titled 'Softkey Layout' and contains the following configuration options:

- Custom Softkey:** A dropdown menu set to 'Enable'.
- Call States:** A dropdown menu set to 'Dialing'.
- Disable Keys / Unselected Softkeys:** A list box containing 'Empty', 'Call Switch', 'Directory', 'DPickup', 'Line', and 'GPickup'.
- Enable Keys / Selected Softkeys(ordered by position)**:** A list box containing 'Send', 'IME', 'Delete', and 'EndCall'.

Navigation buttons between the lists include a right arrow (→) to move items from Disable to Enable, a left arrow (←) to move items from Enable to Disable, an up arrow (↑) to move items up in the Enable list, and a down arrow (↓) to move items down in the Enable list. At the bottom of the configuration area are buttons for 'SaveSet', 'Cancel', and 'Reset to Default'. A 'NOTE' box is visible on the right side of the interface.

Note:
 When there more than 5 items in the Enable field, the last soft key will display More, and last two item will show in the next page soft key, you can check by press more.

Programmable Key

For the default keys as Soft keys, Navigation keys and so on, you can define them as some specific feature, and it works only on the idle page.

To configure Programmable Key via Web interface :

1. Click Function Keys→ Programmable Keys
2. Select the desired Key to set.
3. Click **SaveSet** to save the setting.
4. By clicking **Reset To Default** , all setting of the keys will be back to default.

[logout](#)

Home | Profile | Account | Network | **Function Keys** | Setting | Directory | Management

Line Key
 Programmable Key
 EXP KEY

Key	Type	Label	Account	Value
SoftKey1	History		Account 1	
SoftKey2	Directory		Account 1	
SoftKey3	DND		Account 1	
SoftKey4	Menu		Account 1	

Key	Type	Account	Value
Up	History	Account 1	
Down	Directory	Account 1	
Left	Switch Account Up	Account 1	
Right	Switch Account Dowr	Account 1	
OK	Status	Account 1	
Cancel	N/A	Account 1	
MUTE	N/A	Account 1	
CONF	N/A	Account 1	
TRAN	Forward	Account 1	
HOLD	N/A	Account 1	
Speaker	Speaker	Account 1	
Headset	Headset	Account 1	
VM	VM	Account 1	
Volume Up	Volume Up	Account 1	
Volume Down	Volume Down	Account 1	

NOTE

Exp Key



It only works when there is expansion module connected with the phone.
For Exp Key configuration, please refer to: [UC46 User manual](#).

Basic Call Features



Place a Call

There are three ways to dialing a call: Handset, Headset and Hands-free loud speaker.



To place a call by Handset

1. Pick up the handset, or press a line key and dial the necessary number.
2. Press  or  or press the send soft key, then the call is sending.

To place a call by Headset:

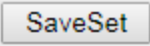

1. Press the  (light is Green),
2. Enter the desired number.
3. Press  or , or press the Send soft key, then the call is sending.

Using headset to place and answer calls for all time





1. Click webpage Setting → Preference
2. HeadSet Priority → Enable
3. Ring Device for HeadSet → User Headset
4. Click  to save the setting.
5. Press 

HeadSet Priority	Enable ▼
Ringer Device For HeadSet	Use HeadSe ▼

Placing a call by hands-free speakerphone

1. Press the , or press the Line key, then you can hear the dial tone.
2. Press the number.
3. Press  or  press the Send soft key, then the call is sending.

To place a call by call history or Directory via Phone interface.

1. Press the History /Directory soft key (On the idle page) or Menu → History /Directory
2. Press  and  to select the targeted one.
3. Press the Send soft key, or , or , or the corresponding line key, then the call is sending.

Note:

1. The  key is set to be a send key. For more information, refer to the **Key as Send** on page
2. During the call, you can also change among Headset, Handset or Free-speaker mode.

Making two calls with one line and one account

1. Press a line key and dial the phone number, then make a call.
2. Press Hold soft key and then press New Call soft key.
3. Dial another phone number,
4. Press the Send soft key, or , then make the second call.



End a Call

Here shows to end a call during three modes:



To end a call by Handset

Press the End Call soft key or hang up the handset, or press 

To end a call under Headset Mode

Press the End Call soft key or press , or press .

To end a call under hands-free speakerphone Mode

Press the End Call soft key or press , or press .

Note:

During the conference, to end the call is same as mentioned above.

Redial a Call

To redial the last placed call from the IP Phone:

Press  directly when LCD is on the idle interface.

Receive a Call

There are three ways to receive a call when the phone is ringing:

To receive a call by handset

Pick up the handset and now the conversation is built.

To receive a call by headset

Press  and now the conversation is built.

To receive a call by hands-free speaker

1. Option 1: Press  directly.
2. Option 2: Press Answer soft key.
3. Option 3: Press the Line key (flashes red).

Moreover, some other action can be done by soft key when the call is coming.

1. To press the Reject soft key to reject the call. Or press  to reject the current call.
2. To press Forward to forward to another phone.
3. To press Silence soft key, and then the call will keep silent, no ring tone display.

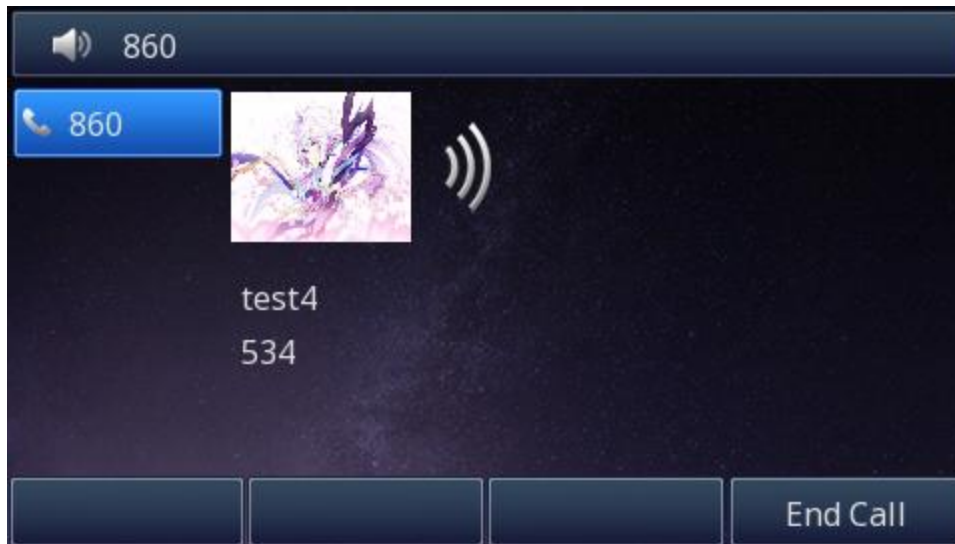

Incoming Call Show Mode

There are two incoming call show modes for this phone:

1. name and number of the contacts
2. name and number of the incoming call and the account which is connecting

To set incoming call show mode via Web interface :

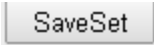
1. Click setting→ preference
2. Select the desire mode for the incoming call show mode
3. Click  to save the setting.

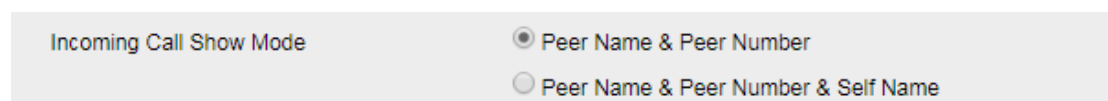

Auto Answer

Enable auto answer feature, you will answer all incoming call automatically.

To enable Auto Answer via Web interface

1. To Click Profile → Advanced
2. To choose Yes for the Auto Answer.
3. To click SaveSet to save the configuration.

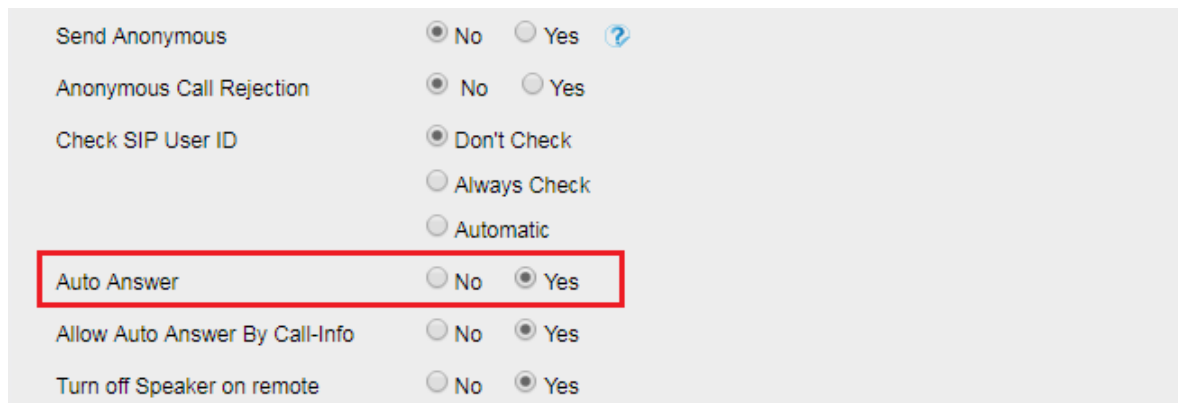

Send Anonymous	<input checked="" type="radio"/> No	<input type="radio"/> Yes	?
Anonymous Call Rejection	<input checked="" type="radio"/> No	<input type="radio"/> Yes	
Check SIP User ID	<input checked="" type="radio"/> Don't Check	<input type="radio"/> Always Check	<input type="radio"/> Automatic
Auto Answer	<input type="radio"/> No	<input checked="" type="radio"/> Yes	
Allow Auto Answer By Call-Info	<input type="radio"/> No	<input checked="" type="radio"/> Yes	
Turn off Speaker on remote	<input type="radio"/> No	<input checked="" type="radio"/> Yes	

To Disable Auto Answer via Webpage

1. To Click Profile → Advanced
2. To choose No for the Auto Answer.
3. To click SaveSet to save the configuration.



Call Hold

When using the hold feature, the Hold icon will show on the display.





To make a call on hold during three modes:



To hold a call under handset mode:

1. Press Hold soft key or  to hold the current call.
2. Press Resume soft key or  to resume the call on hold.

To hold a call under headset mode:

1. Press Hold soft key or  to hold the current call.
2. Press Resume soft key or  to resume the call on hold.

To hold a call during the speaker mode:



1. Press Hold soft key or  to hold the current call.
2. Press Resume soft key or  to resume the call on hold.

Call Transfer

This phone supports blind, attended and Semi-Attended Transfer.

Blind Transfer

When you use this feature, you can transfer



1. Press  or Transfer soft key during the conversation, the call is on hold now.
2. Enter the number that transfers to.
3. Press  or Transfer soft key, and now the blind transfer completed.

Attended Transfer

When you use this feature, you can

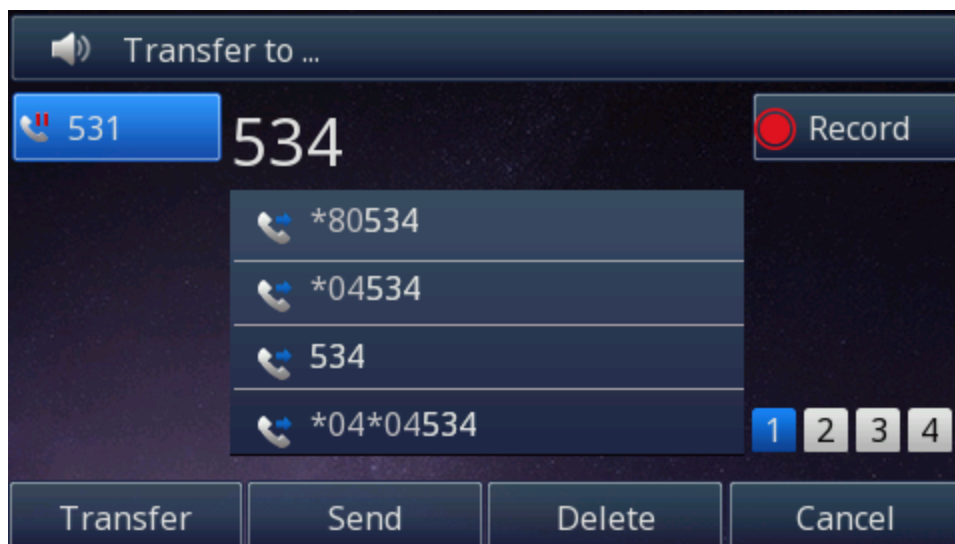
1. Press  or Transfer soft key during the conversation, the call is on hold now.







2. Enter the number that transfer to, and press the send soft key or  or .
3. Start the second conversation, press  or Transfer soft key, then, transfer completed.

NOTE:

To transfer calls across SIP domains, SIP service providers must support transfer across SIP domains. Blind transfer will usually use the primary account SIP profile.

Semi-Attended Transfer

1. Press  or Transfer soft key during the conversation, the call is on hold now.
2. Enter the number transfer to, and then press  or , then you can hear the ring tone.
3. Press  or the Transfer soft key, and now the Semi-attended transfer completed.

BLF Transfer

1. Set a Programmable Key or line key is set as BLF. For how to set BLF, please refer to [BLF](#)
2. Press  or Transfer soft key during the conversation, the call is on hold now.
3. Press BLF key then realize blind, attended and Semi-Attended Transfer.

Hold transfer on hook:

1. Setting → Features → Transfer Setting: Hold Transfer On Hook: ON.
2. A place a call to B, B answer, A press the hold soft key and place a call to C, A cancel the call when C is ringing or answering, then C and B in the same call and the transfer is successful.

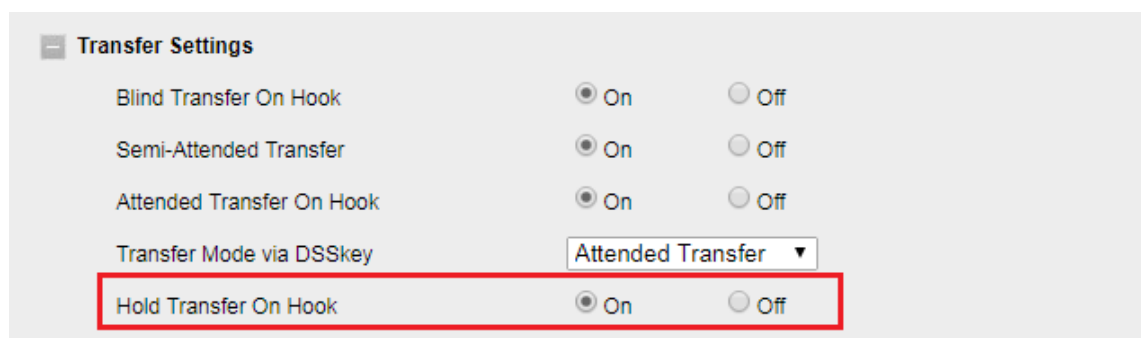

Hold transfer on Three Way conference:

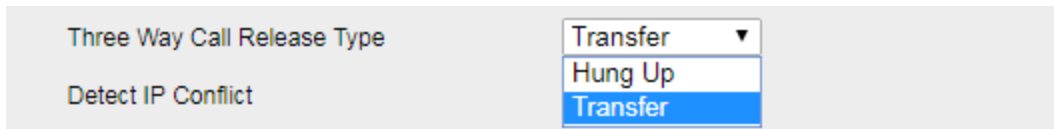
1. Setting → Preference → Three Way Call Release Type: Transfer.
2. A place a call to B, B answer, A place a call to C again, C answer, A press the conference then A, B and C will establish meeting.
3. A press the End Call soft key or on-hook to exit the meeting in the process of talking.
4. Then B and C will continue to talk.

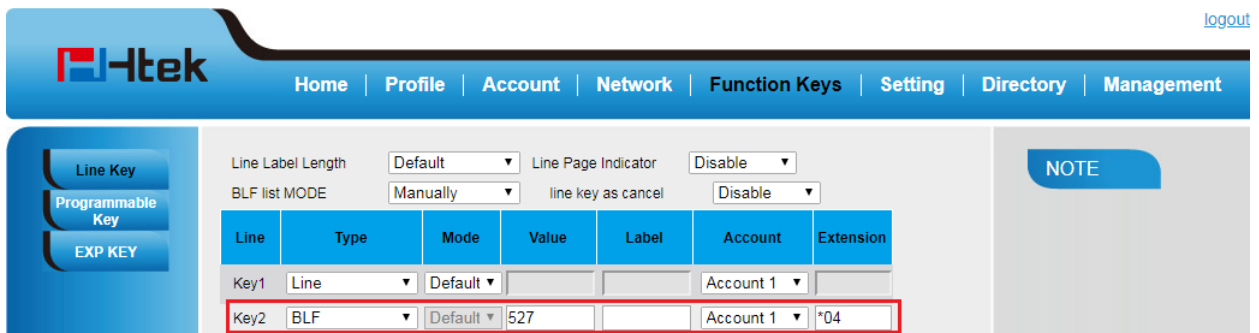
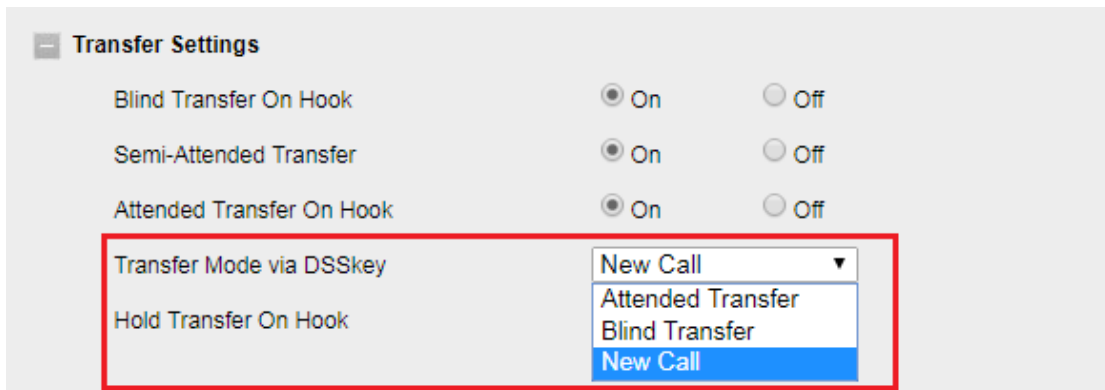

Transfer to New Call via Web interface

1. Click Setting → Features
2. Select Transfer Mode via DSS key → New Call
3. Select the desired Line Key and select Transfer in the Type.
4. Enter the phone number in the Value field.









NOTE: if the person that wanted to be spoken to do not want to answer the call, then the person that answered the coming call could use this function.

Call Conference

This IP Phone supports up to 5-way conference.

5-way conference

1. Assuming that call party **A** and **B** are in conversation. **A** wants to bring **C**, **D** and **E** in a conference
2. **A** press the Conference soft key, the call is placed on hold.
3. **A** enter the number of **C** and then press send soft key or .
4. **C** answering the call.
5. **A** press  or the conference soft key, then **A**, **B** and **C** are now in a conference. (and now this is **3-way conference**)
6. **A** press the Conference soft key, the current 3-way conference is placed on hold.
7. **A** enter the number of **D** and then press send soft key or .
8. **D** answering the call.
9. **A** press  or the conference soft key, then **A**, **B**, **C** and **D** are now in a conference. (and now this is **4-way conference**)
10. **A** press the Conference soft key, the call is placed on hold.
11. **A** enter the number of **E** and then press send soft key or .
12. **E** answering the call.
13. **A** press  or the conference soft key, then **A**, **B**, **C**, **D** and **E** are now the **5-way conference** is built.
14. **A** end the call, the conference is finished.

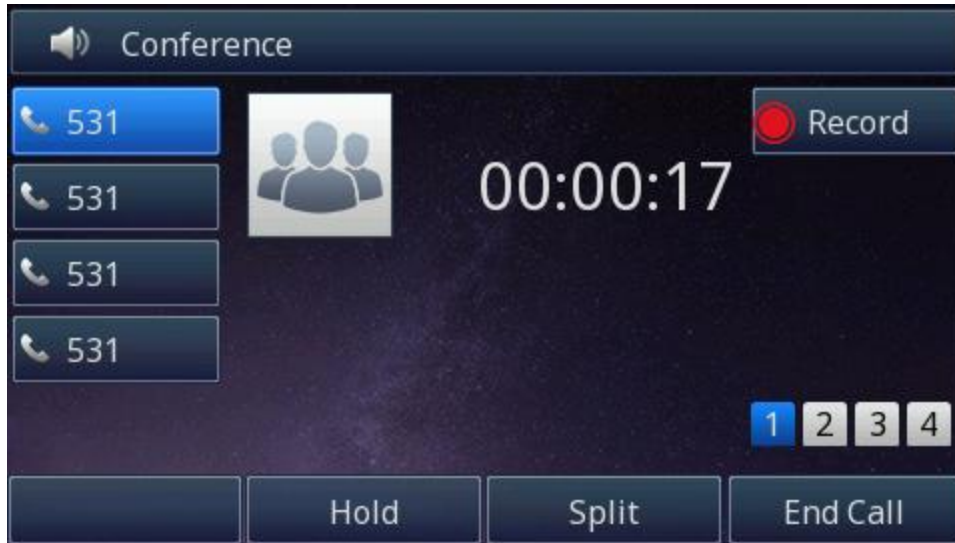
Note:

1. If **C** does not answer the call, **A** can back to continue the conversation with **B**;
2. Once **A** hangs up the call, the conference is ended, while if **B** or **C** drops the call, **A&C** or **A&B** conversation continues.
3. The conference feature is not available on all servers. For more information, contact your system administrator.
4. To realize the 5-way conference, the line should be all available.

Call Forward

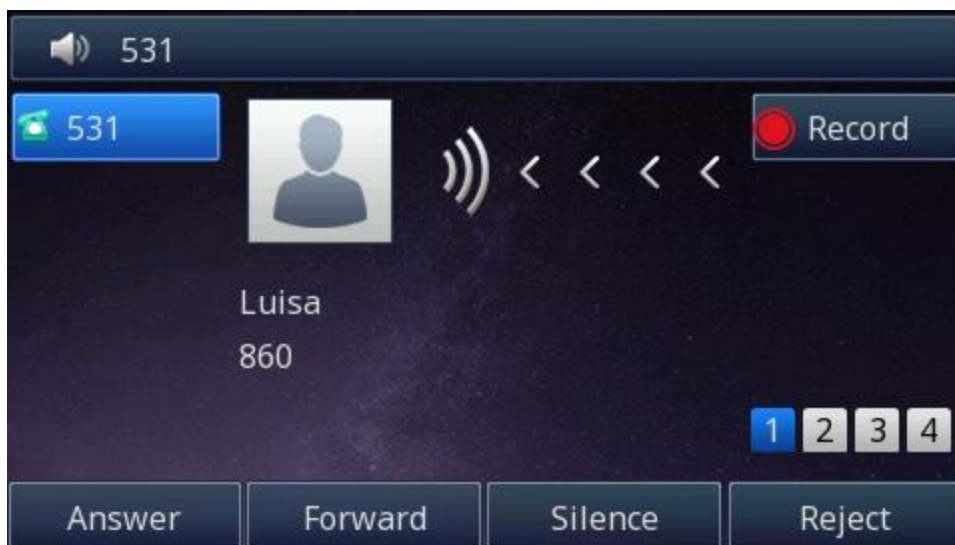

This phone supports static forward (always forward, busy forward and no answer forward) and dynamic forward



To configure static forward

To configure always forward

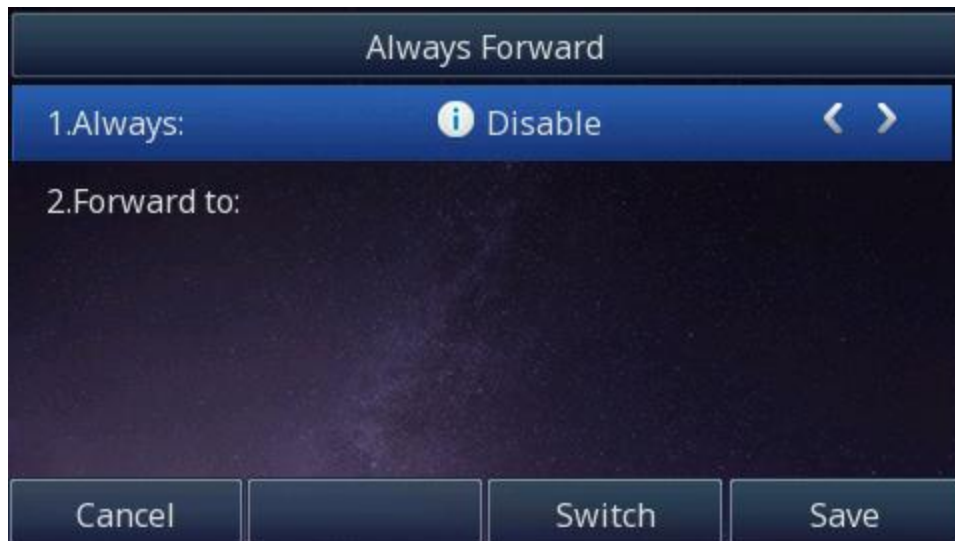

With this feature, all incoming calls will forward immediately to configured number.

1. Press Menu → Features → Call forward →Always Forward.
2. Press  and  to select the enable choice
3. Enter the Forward To number.
4. Press  or Save soft key to save the configuration.



To configure busy forward

With this feature, the incoming calls are immediately forwarded if the phone is busy.

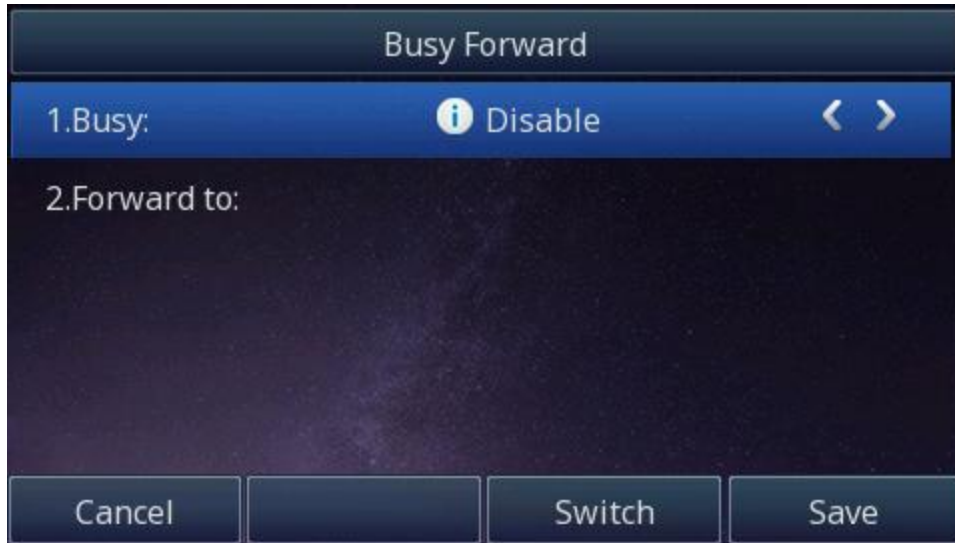

1. Press Menu →Features → Call forward →Busy forward.
2. Press  and  to select the enable choice.
3. Enter the Forward To number.
4. Press  or Save soft key to save the configuration.



To configure no answer forward

No Answer Forward: Incoming calls are forwarded if not answered after some time.

1. Press Menu → Features → Call forward → No answer forward.

2. Press  and  to select the enable choice

3. Enter the Forward To number and After Ring Times.

4. Press  or Save soft key to save the configuration.

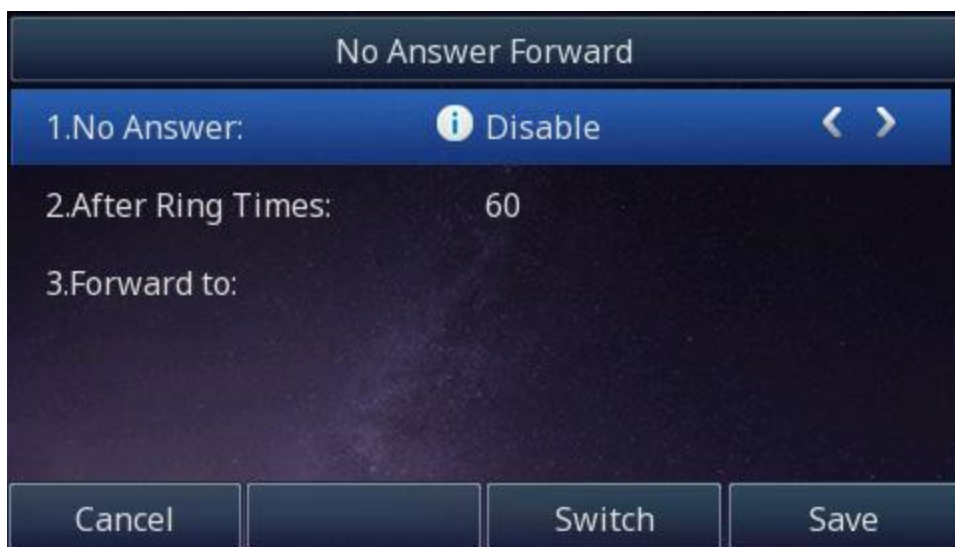

When the Forward feature is enabled, the icon  will display on Top of the LCD.

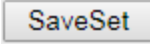

To configure Forward via Web interface

1. Setting → Features
2. Click On for the Always/Busy/No Answer
3. Fill the Target Number
4. Fill the After Ring Time
5. Click  to save the configuration



Forward: ?

Always	<input type="radio"/> On	<input checked="" type="radio"/> Off	
Target	<input type="text"/>		?
Busy	<input type="radio"/> On	<input checked="" type="radio"/> Off	
Target	<input type="text"/>		?
No Answer	<input type="radio"/> On	<input checked="" type="radio"/> Off	
After Ring Time(seconds)	<input type="text" value="60"/>		?
Target	<input type="text"/>		?

To cancel the forward feature via Phone interface

1. Option 1: To press the  key to disable the forward feature.

- Option 2: Press Menu → Features → Call Forward → Always/Busy/No answer Forward

Press  and  to select the disable choice

Press  or Save soft key to save the configuration.

To cancel the forward feature via Web interface

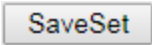
- Setting → Features
- Click Off for the Always/Busy/No Answer
- Click  to save the configuration

To configure dynamic forward

Forward an incoming call during the ringing.

- When the phone is ringing, press Forward soft key.
- Enter the forward number or select the desired number from Directory soft key (Precondition: local directory has one or more contacts).
- Press  or press the send soft key, then the call is forwarded.

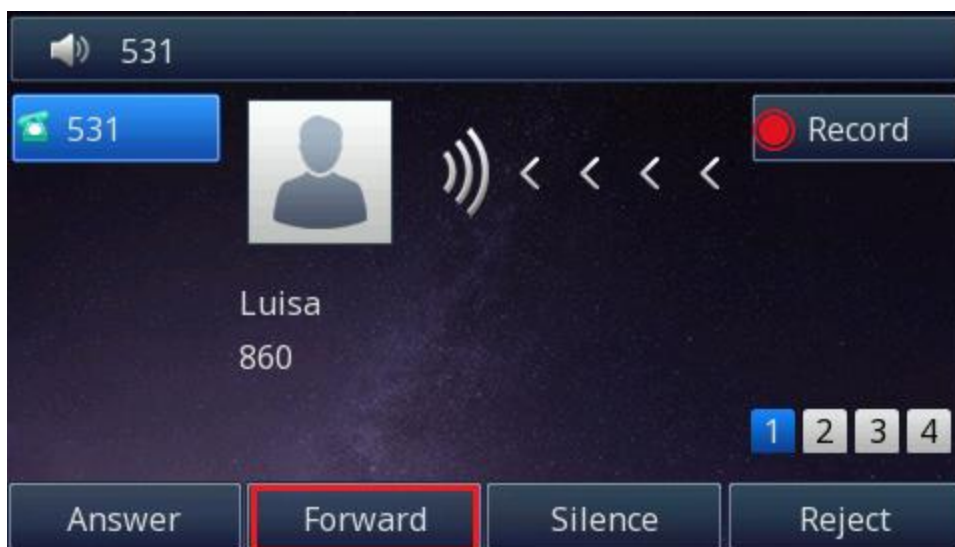

Note:



If the Programmable Key or line key is set as BLF, when an incoming call ringing, press this BLF key directly to realize the dynamic forward.

You can choose a desired forward number from the Directory when you press the Forward key.

Call Return

This feature allows you to dial the last phone call you received.

To configure the Call Return via Phone interface

1. Press Menu → Features → Function Keys → Line Keys as Function Keys → Line Key2(for example)
2. Press  and  key to select the Call Return in the Type field.
3. Press  or Save soft key to save the configuration

To configure the Call Return via Web interface

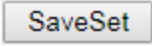
1. Click Function Keys → Line Key.
2. Select the desired Line Key and select Call Return in the Type.
3. Click  to save the configuration.

Call Back

When this option is set, if the phone you call is busy and does not set call waiting or voice mail, your LCD screen will prompt for call-back, as shown in figure

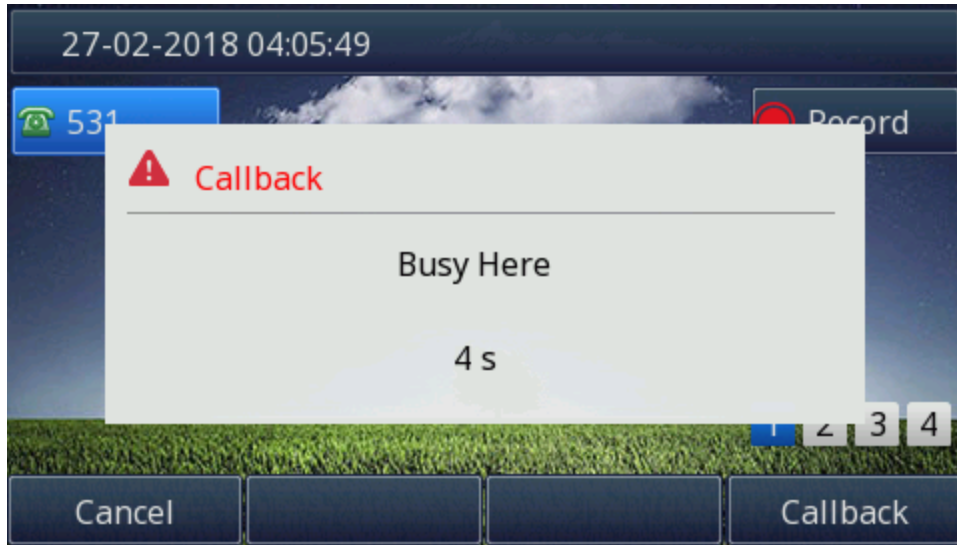

If you press the callback, the phone will dial the Callback phone number.

To configure the Call Back via Web interface

1. Click Setting →Features →Callback .
2. Fill the Callback phone number.
3. Click to save the configuration.

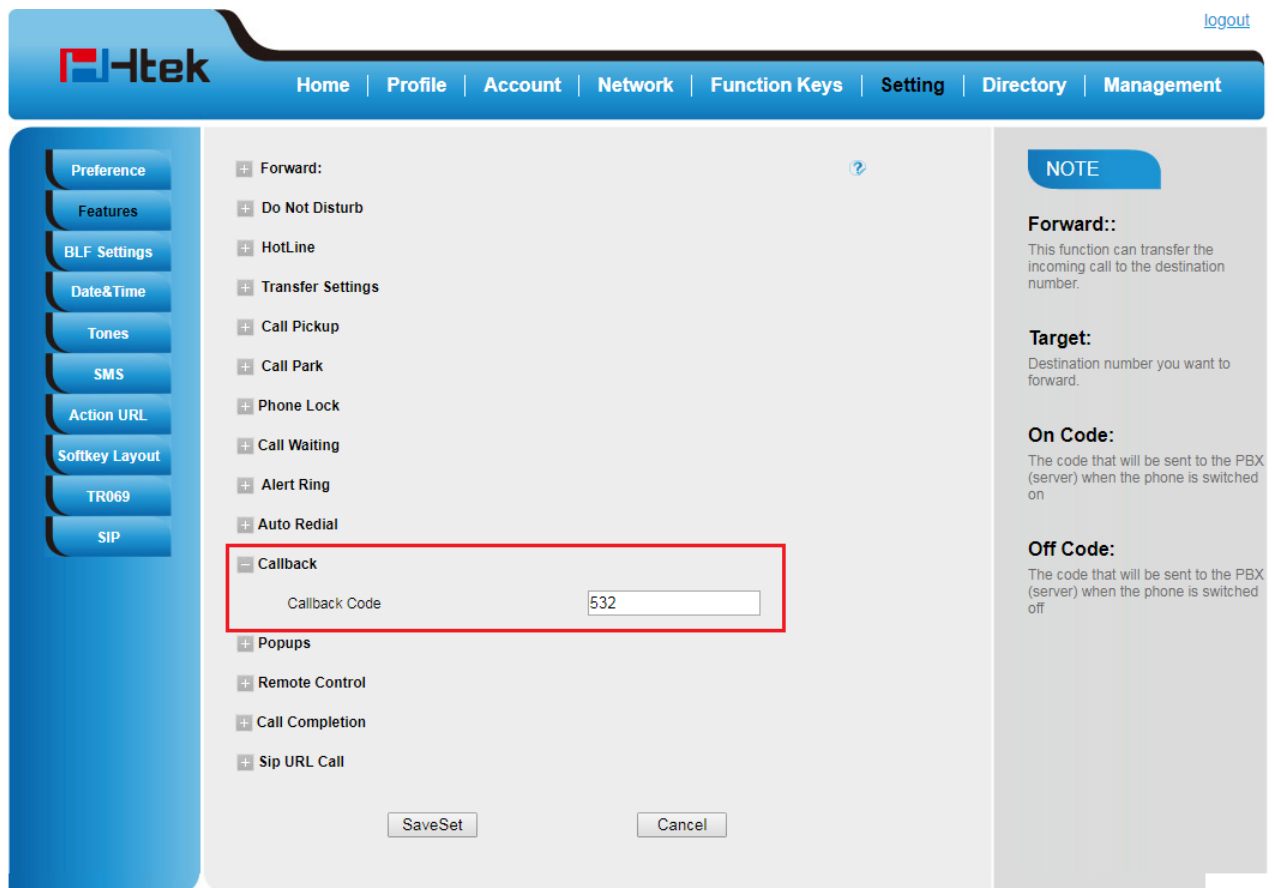

Call Waiting Tone

1. Click Setting → Features
2. Select Call Waiting: On and Call Waiting Tone: On

Call Waiting On Off

Call Waiting Tone On Off

To Change the Call Waiting Tone time via Web interface

1. Click Setting → Tones

Home | Profile | Account | Network | Function Keys | **Setting** | Directory | Management

Preference
Features
BLF Settings
Date&Time
Tones
SMS
Action URL
Softkey Layout
TR069
SIP

Select Country: Custom

Dial Tone: f1=350@-13,f2=440@-13,c=0/0;

Ringback Tone: f1=440@-19,f2=480@-19,c=2000/4000;

Busy Tone: f1=480@-24,f2=620@-24,c=500/500;

Reorder Tone: f1=480@-24,f2=620@-24,c=250/250;

Confirmation Tone: f1=350@-11,f2=440@-11,c=100/100-100/100-100/100;

Call Waiting Tone: f1=440@-13,c=300/10000-300/10000-0/0;

Syntax: f1=freq@vol, f2=freq@vol, c=on1/off1-on2/off2-on3/off3; [...]
Note: freq: 0 - 4000Hz; vol: -30 - 0dBm

SaveSet Cancel

NOTE
Select Country:
Select your country to generate the standard call tones. Or select Custom to customize the call tones.

2. Change the Tone Time as you want (for example 3s)



Call Waiting Tone: f1=440@-13 **c=300/10000-300/10000-0/0;**

Hide Caller ID

Just enable the unknown/hidden caller feature, by enabling Anonymous call feature thereby the receiver won't be able to know who is calling them.



To configure anonymous call

1. Press Menu → Features → Anonymous Call → Account ID 1

2. Press  and  to select the enable choice in Anonymous Call filed.
3. Enter the Call On Code (optional), Call Off Code (optional).
4. Press  or Save soft key to save the configuration.





To cancel anonymous call feature

1. Press Menu →Features →Anonymous Call
2. Press  and  key to select the disable choice in Anonymous Call filed.
3. Press  or Save soft key to save the configuration.

Reject Anonymous

If you do not want to be disturb by anonymous calls, you can set the reject anonymous call features, so you will not hear the unknown calls

To configure rejecting anonymous call

1. Press Menu →Features →Anonymous Call →Account ID 1
2. Press  and  key to select the enable choice in Rejection filed.

3. Press or Save soft key to save the configuration

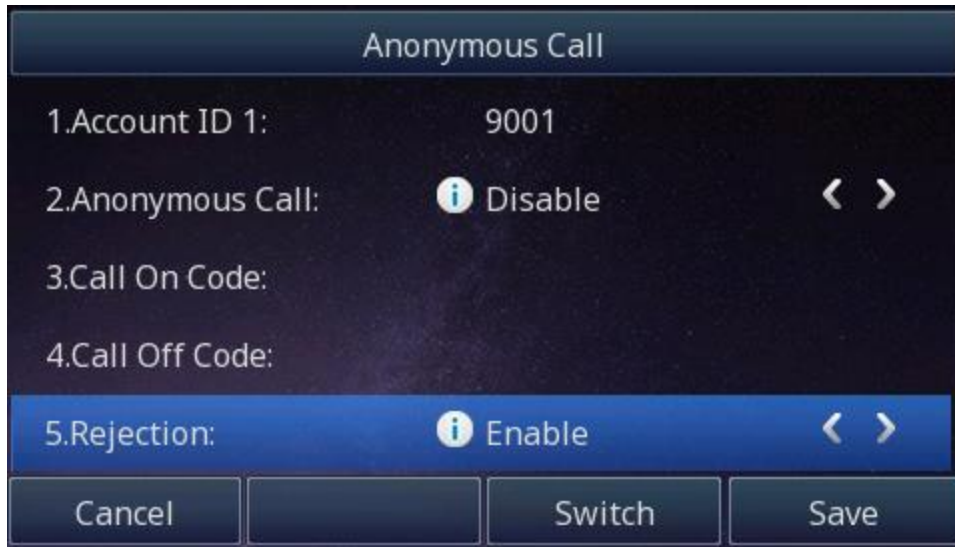

To cancel rejecting anonymous call

1. Press Menu →Features →Anonymous Call →Account ID 1
2. Press and key to select the disable choice in Rejection filed.
3. Press or Save soft key to save the configuration.

Call Mute

When you use the Mute feature, the other parties will not hear your voice while you can hear their voice. Call mute applies to all modes (handset, headset, and speakerphone).

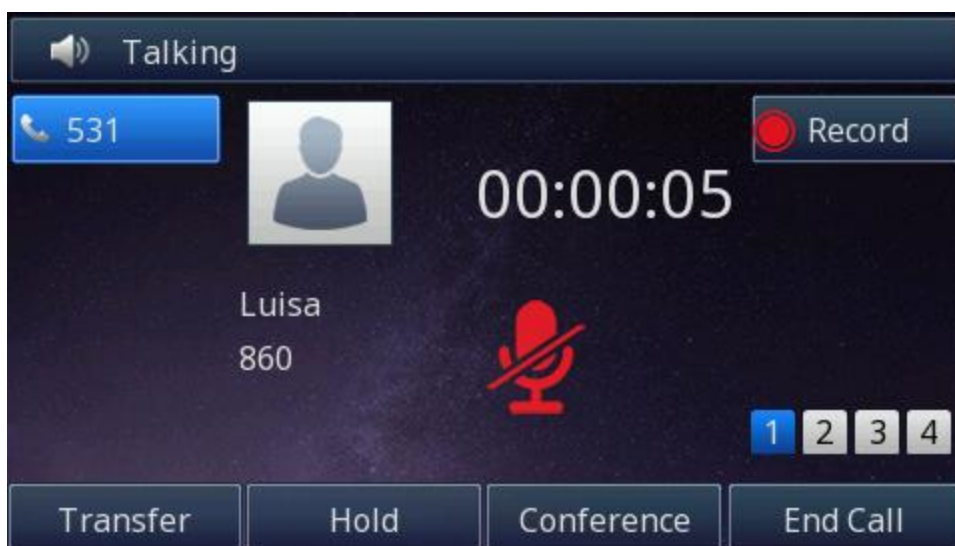

To mute the call during a call (including a conference call)

1. Press the mute key , then the mute key glows green, and the LCD display



2. To disable the mute function, press  again.

DND

When you use the DND feature, the phone is to reject all incoming calls automatically and

you can see the mute icon  shown on the Top of the LCD on idle page.



To enable DND feature via Phone interface :

Press the DND soft key when the phone is idle, and then  shown on the LCD.

To disable DND feature via Phone interface :

Press the DND soft key again, and then there is no  on the LCD.

Hot Line

To configure Hot Line via Phone interface

1. Press Menu → Features → Hot Line
2. Enter the Number and delay time (as present, we support off hook auto dial).
3. Press  or Save soft key to save the configuration

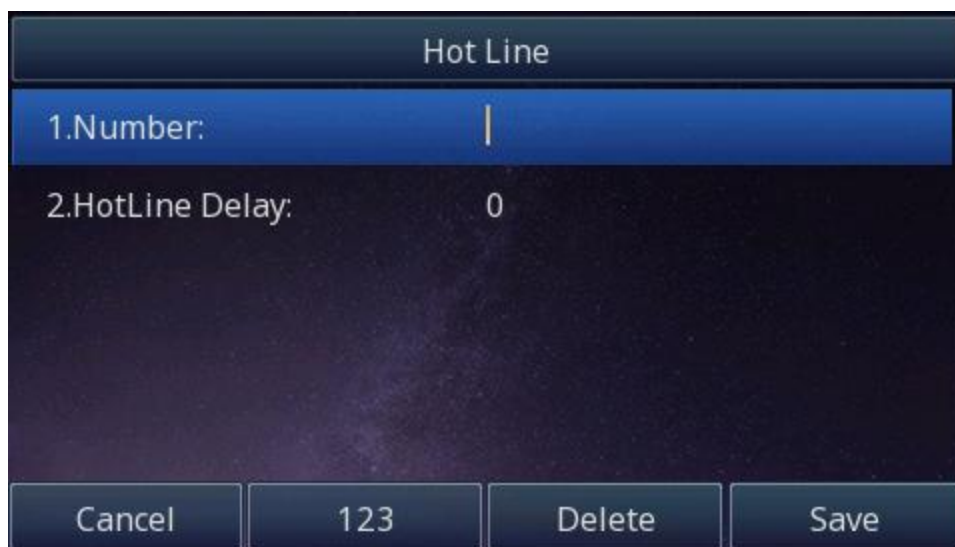

To configure Hotline auto dial via Web interface

1. Setting → Features.
2. Fill the number in the Hotline Number and Hotline Time-out.
3. Click  to save the configuration.

HotLine

Hotline Number

Hotline Time-out(seconds)(0~180s)

Delete the hotline number and save the configuration, then now the Hotline auto dial is cancelled.

Auto Redial

When this option is set, if the phone you call is busy and does not set call waiting or voice mail, your LCD screen will prompt for Auto Redial, as shown in figure.



If you press OK, your LCD will prompt Auto Redial Interval and Auto Redial Times

To configure Auto Redial via Web interface

1. Click Setting → Features → Auto Redial
2. Select On or Off for Auto Redial.
3. Fill the number 1~300 seconds for the Auto Redial Interval.
4. Fill the number 1~300 times for the Auto Redial Times.
5. Click to save the configuration.



Function Key Features and Settings

The function key supports the **Line Label Length**, **Line Page Indicator**, **BLF list MODE**,

line key as cancel:

Line Label Length: if this option is set Long label, then the label's length will be longer, it is used if the string is too long.

Line Page Indicator: Enable this option When the phone has been configured for four pages and current page is first page, the forth page has a BLF and BLF's status is changed, then the forth page's button will flash the red indicator.

UC926E has 36 Function Keys.

Line

It works same as Line keys.

Line support three Mode (Default, lock and float)

Default mode: If there is an incoming call, the phone won't navigate to the set line key account page if the line key page is set as line type and current page is page four.

Lock mode: If there is an incoming call the line key set account will reflect on the same position on every page when the first page set as the line type.

Float mode: If there is an incoming call, the phone will navigate to the set line key account page if the line key page is set as line type and current page is page four.

To configure Line Feature via Web interface

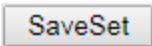
1. Click Function Keys → Line Key.
2. Select the wanted Key and set as Line.
3. Select the Account.
4. Click the  button to save the configuration.

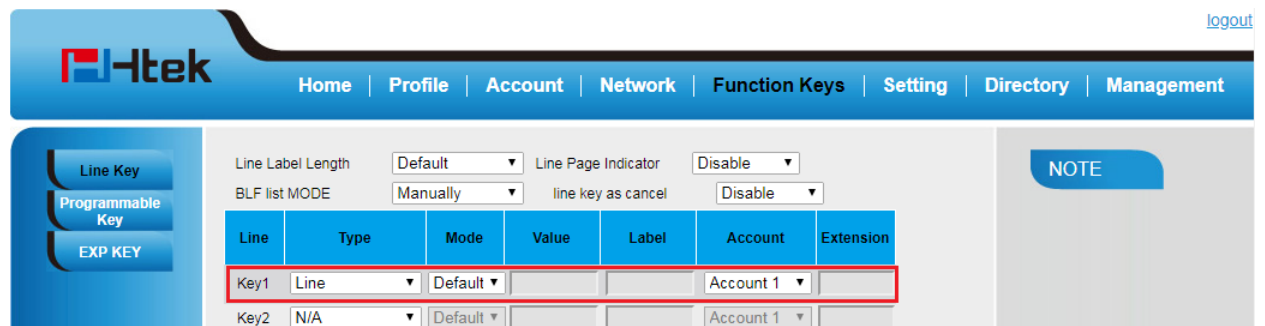

logout

Home | Profile | Account | Network | **Function Keys** | Setting | Directory | Management

Line Key
Programmable Key
EXP KEY

Line Label Length: Default | Line Page Indicator: Disable
BLF list MODE: Manually | line key as cancel: Disable



Line	Type	Mode	Value	Label	Account	Extension
Key1	Line	Default			Account 1	
Key2	N/A	Default			Account 1	

NOTE

Speed Dial

With this feature, you can dial one number by pressing the configured speed dial key.

To configure Speed Dial feature via Phone interface

1. Press Menu → Features → Function Keys → Line Keys as Function Keys → Line Key2(for example)
2. Press  and  key to select the Speed Dial in the Type field.
3. Enter the targeted Number.
4. Press  or Save soft key to save the configuration

Then the selected Line Key will work as Speed Dial.

To configure Speed Dial feature via Web interface

1. Click Function Keys → Line Key.
2. Select the wanted Line Key and set as Speed Dial.
3. Enter the desired phone number in the Value field.
4. Select the Account ID
5. Click the  button to save the configuration.

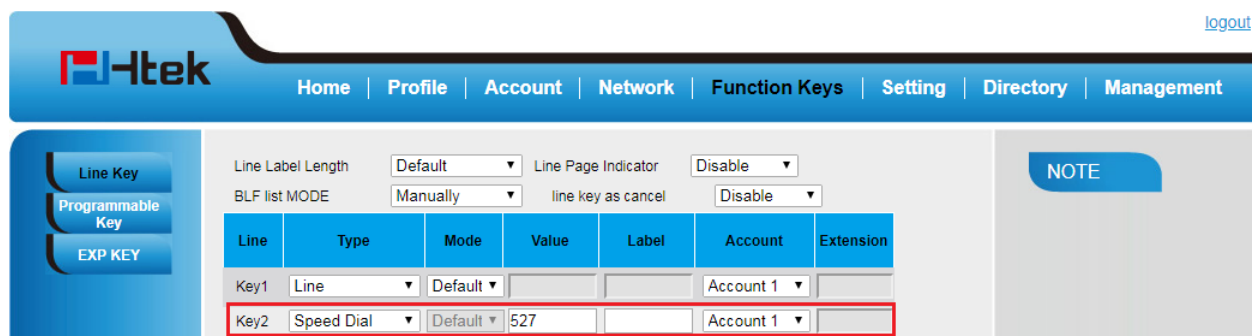

logout

Home | Profile | Account | Network | **Function Keys** | Setting | Directory | Management

Line Key
Programmable Key
EXP KEY

Line Label Length: Default | Line Page Indicator: Disable
BLF list MODE: Manually | line key as cancel: Disable

Line	Type	Mode	Value	Label	Account	Extension
Key1	Line	Default			Account 1	
Key2	Speed Dial	Default	527		Account 1	





NOTE

BLF

You can use the BLF (Busy Lamp Field) feature to monitor a specific extension number whether the extension is busy or free.

1. When the extension you are monitoring is idle, the light is steady green.
2. When the monitored extension is ringing, the light is blinking red, press the BLF key to pick the phone up directly.
3. When the monitored extension is calling or in a conversation, the light is steady red.

To configure a BLF key via Phone interface

1. Press Menu → Features → Function Keys → Line Keys as Function Keys → Line Key2(for example).
2. Select the targeted Line Key.
3. Press  and  key to select the BLF in the Type field.
4. Enter the targeted Value Number.
5. Press  and  key to select the Account ID.
6. Enter the Pickup Code.
7. Press  or Save soft key to save the configuration

To configure a BLF key via Phone interface

1. Click Function Keys → Line Key.
2. Select the desired Line Key and select BLF in the Type.
3. Enter the monitored phone number in the Value field.
4. Select the Account ID
5. Filled the Extension.

6. Click to save the configuration.

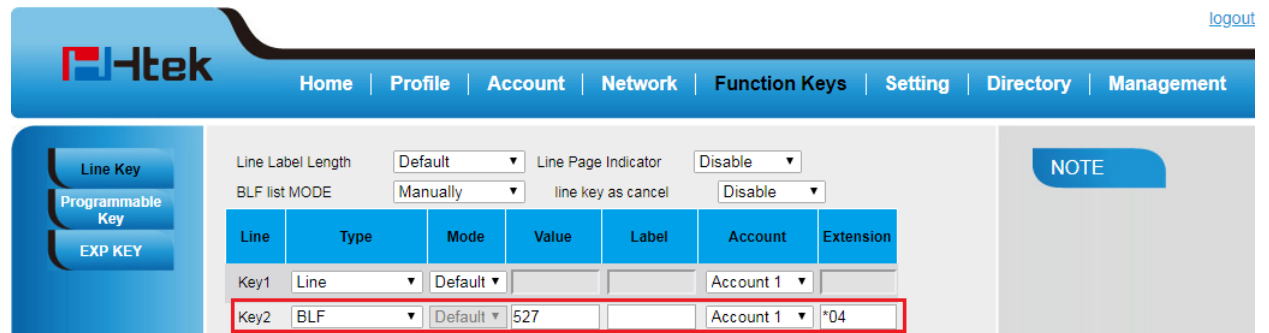

Note:
 This feature is not available on all servers. For more information, contact your system administrator.
 After setting the BLF key, do not need to restart the phone.

Visual Alert for BLF Pickup

If this option is on, when you use the BLF feature to monitor a specific phone whether it is busy or free, you can see this message on the LCD, as shown in the following figure.



To configure Visual Alert for BLF Pickup via Web interface

1. Click Setting → Features → Call Pickup → Visual Alert for BLF Pickup
2. Select Enable or Disable for Visual Alert for BLF Pickup.

3. Click to save the configuration.



Call Pickup	
Call Pickup Mode	FAC ▼
Direct Call Pickup	Disable ▼
Direct Call Pickup Code	<input type="text"/>
Group Call Pickup	Disable ▼
Group Call Pickup Code	<input type="text"/>
Visual Alert for BLF Pickup	Enable ▼
Audio Alert for BLF Pickup	Disable ▼

Audio Alert for BLF Pickup

If this option is on, when you use the BLF feature to monitor a specific phone whether it is busy or free, you can hear beep.

To configure Audio Alert for BLF Pickup via Web interface

1. Click Setting → Features → Call Pickup → Audio Alert for BLF Pickup
2. Select Enable or Disable for Audio Alert for BLF Pickup
3. Click to save the configuration.

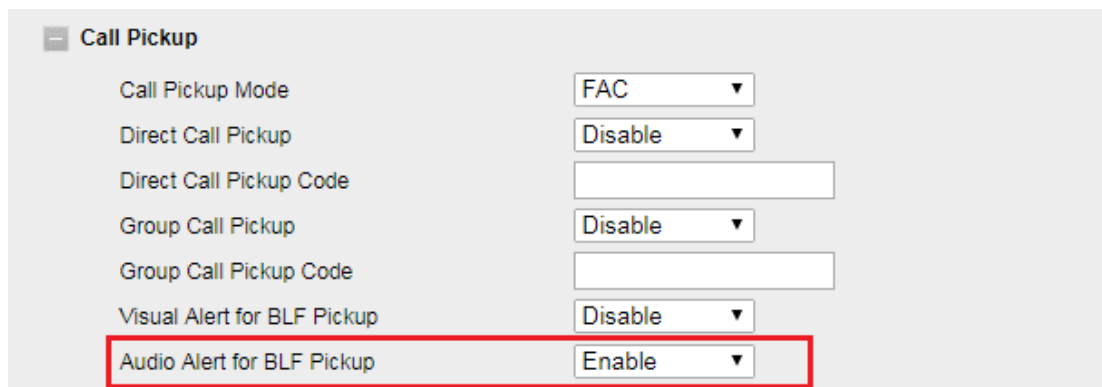

Call Pickup	
Call Pickup Mode	FAC ▼
Direct Call Pickup	Disable ▼
Direct Call Pickup Code	<input type="text"/>
Group Call Pickup	Disable ▼
Group Call Pickup Code	<input type="text"/>
Visual Alert for BLF Pickup	Disable ▼
Audio Alert for BLF Pickup	Enable ▼

BLF List

To configure BLF List via Web interface:

1. Login and click Account→Basic
2. Fill the Eventlist BLF URL and click  to save the configuration.

Account 1

Account Status Registered

* Account Active No Yes

Profile Profile 1

Label

* SIP User ID 531

* Authenticate ID 531

* Authenticate Password

Name

Local SIP Port 5060

Use Random Port No Yes

Voice Mail UserID

Dial Plan {[x*]+}

Eventlist BLF URL

Shared Line Disable

SCA Barge-In Disable

Direct Call Pickup Code *04

Group Call Pickup Code

Feature Key Sync Disable

SaveSet Restart

NOTE
The * fields must be filled (requires a phone restart)

Basic:
The Basic parameters configured by the administrator.

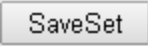
3. To configure BLF List Keys
 - 3.1 Click→ Function Keys→ Line Key
 - 3.2 Select the BLF List in the Type Field.
 - 3.3. Select Account
 - 3.4 Click  to save the configuration.

For more information, please check [BLF list Note](#) on www.htek.com .

Voice Message

This phone supports Voicemail, and when there is a message, the message  will light green. Moreover, when you pick up the handset, or press speaker key, you will hear some faster busy tone.



To configure the Voice mail feature via Phone interface :



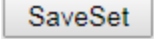

1. Press Menu → Messages → Voice Mail → Set Voice Mail.
2. Enter the Account No.1/2/3/4/5/6.../16.
3. Press  or Save soft key to save the configuration

To configure Voice Mail Line Key via Web interface :

1. Click Function Keys → Line Key.
2. Select the wanted Key.
3. Enter the desired voicemail feature codes in the Value field.
4. Fill the Label name to be displayed on LCD.
5. Select the Account.

6. Click  to save the configuration.

To configure a Voice mail key via Phone interface:

1. Press Menu →Features →Function Keys →Line Keys as Function Keys → Line Key2(for example).
2. Select the targeted Line Key.
3. Press  and  key to select the Voice Mail in the Type field.
4. Enter the Value Number.
5. Press  and  key to select the Account ID.
6. Press  or Save soft key to save the configuration

To leave a voice mail:

You can leave a voice mail when the receiver is busy or its inconvenient for them to answer the call. Follow the voice prompt from the system server to leave a voice mail, and then hang up.

To listen to voice mails:

When the phone interface prompts receiving new voice mail's icon, the power indicator LED flashes red(Setting->Preference: Enable Voice Message Status) and the voice message button flashes green.

1. Pressing  or the targeted Line Key to dial out the voice mail access code.
2. Follow the voice prompt to listen to voice mail.

To view the voicemail via Phone interface:

Press Menu->Messages->Voice Mail->View Voice Mail.

The LCD screen displays the amount of new and old voice mails

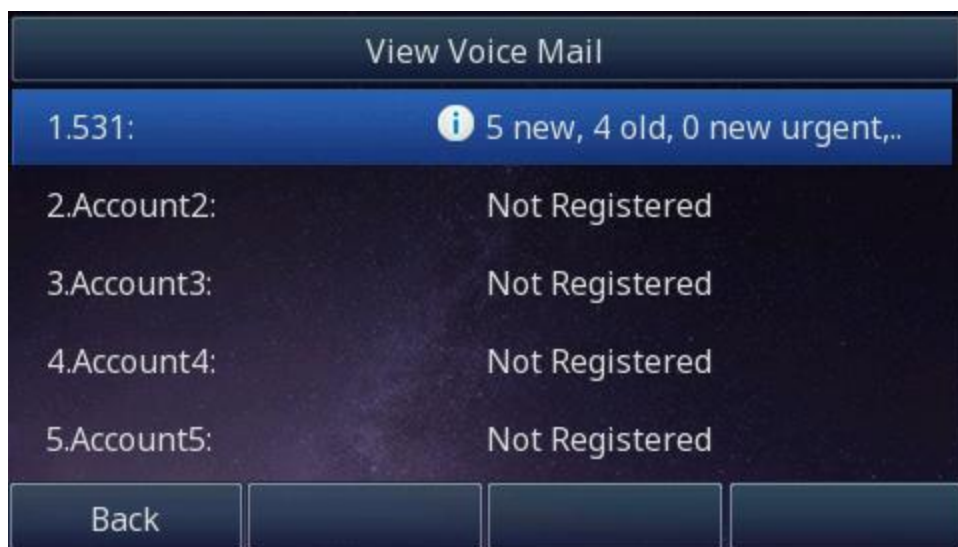
Note:

This feature is not available on all servers. For more information, contact your system administrator.





Before listening to voice mails, make sure the voice mail access code has been configured.

When all new voice mails are retrieved, the power indicator LED, voice mail indicator LED and targeted Line Key will go out.

Direct Pickup

With this feature, you can pick up the set line when it ringing.

To configure Direct Pickup feature via Phone interface

1. Press Menu → Features → Function Keys → Line Keys as Function Keys → Line Key2(for example)
2. Press  and  key to select the PickUP in the Type field.
3. Enter the value.
4. Press  and  key to select the Account ID.
5. Press  or Save soft key to save the configuration

Then the selected Line Key will work as Direct Pickup.

To configure Direct Pickup feature via Web interface

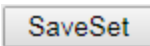

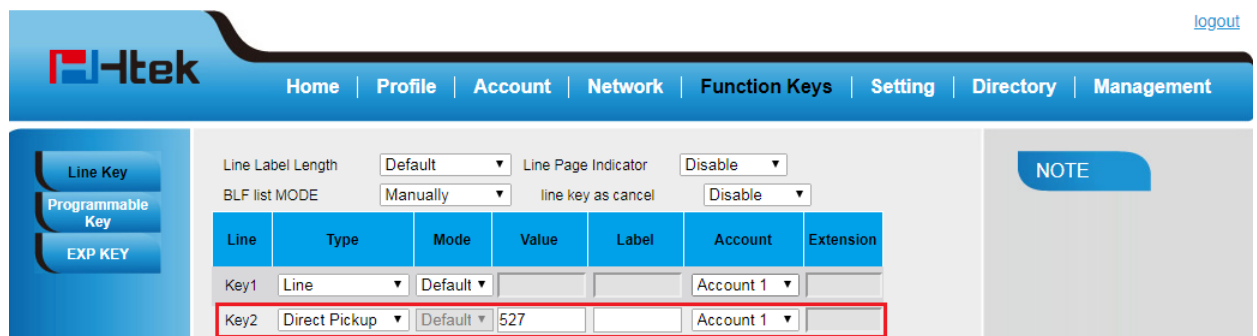
1. Click Function Keys → Line Key.
2. Select the wanted Line Key and set as Direct Pickup.
3. Enter the desired phone number in the Value field.
4. Select the Account ID
5. Click  to save the configuration.



Group Pickup

With this feature, you can pick up the specified group that you want incoming calls.

To configure the Pickup via Phone interface

1. Press Menu → Features → Function Keys → Line Keys as Function Keys → Line Key2 (for example)
2. Select the wanted Line Key.
3. Press  and  key to select the Group in the Type field.
4. Enter the group pickup code or the direct pickup code followed the desired phone number.
5. Press  or Save soft key to save the configuration

To configure the Group Pickup via Web interface

1. Click Function Keys → Line Key.
2. Select the desired Line Key and select Group Pickup in the Type.
3. Enter the group pickup code or the direct pickup code followed the desired phone number in the Value field.
4. Select the Account.
5. Click to save the configuration.

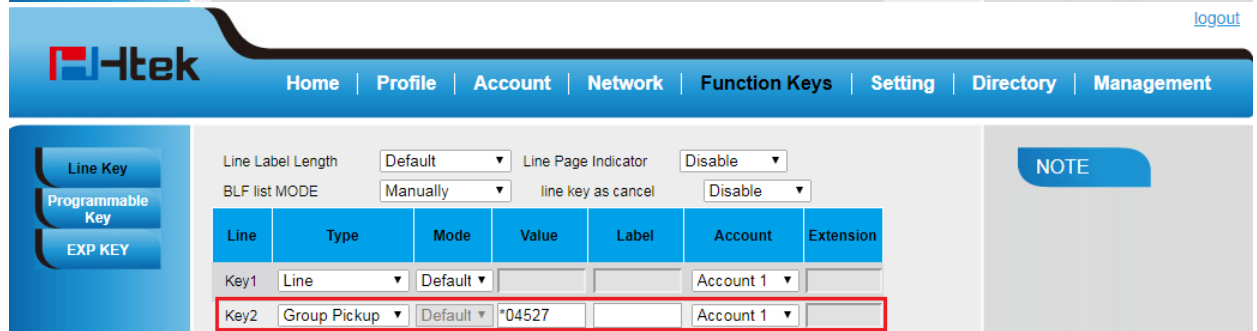
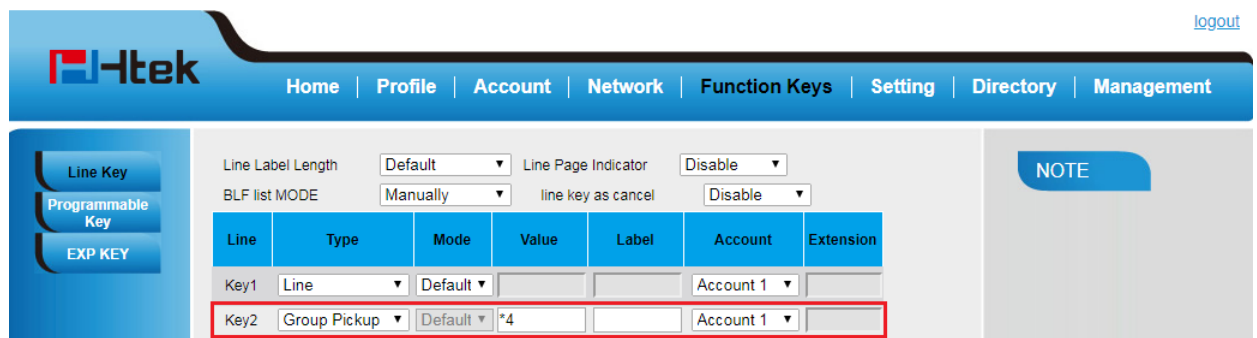

Call Park

With this feature, you can put a call on hold and continue the conversation from another phone.

To configure the Call Park via Phone interface

1. Press Menu → Features → Function Keys → Line Keys as Function Keys → Line Key2 (for example)
2. Press and or press Switch soft key to select the Call Park.
3. Select the Account ID.
4. Enter the call park code in the Value field
5. Press or Save soft key to save the configuration

To configure the Call Park via Web interface

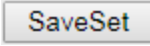
1. Click Function Keys → Line Key.
2. Select the desired Line Key and select call park in the Type.
3. Enter the call park code in the value field.
4. Select the Account.
5. Click the  button to save the configuration.

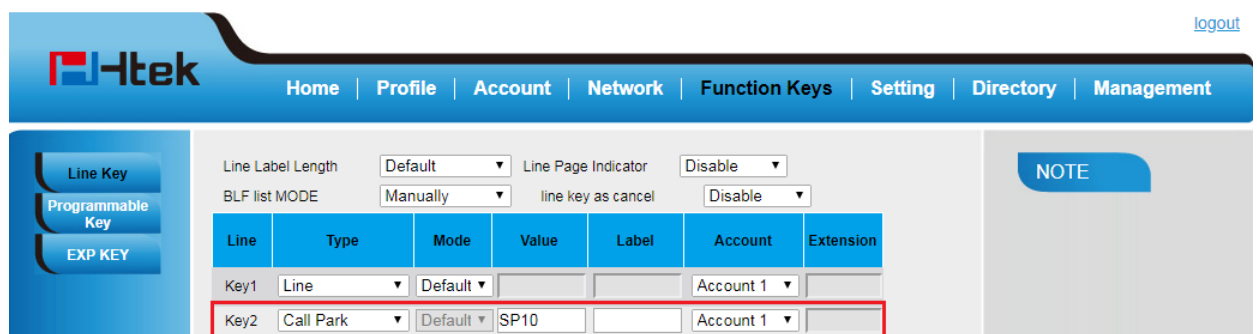



For More information for Call Park, please see: [Call park note](http://www.htek.com/Call_park_note) on www.htek.com/

Intercom

When use the intercom feature, you can quickly get access connect to the configured one.

To configure intercom feature via Phone interface

1. Press Menu → Features → Function Keys → Line Keys as Function Keys → Line Key2(for example)
 2. Press  and  key to select the intercom in the Type field.
 3. Enter the intercom codes followed by desired number.
 4. Select the Account ID.
 5. Press  or Save soft key to save the configuration
- Then the selected Line Key will work as intercom.

To configure Intercom feature via Web interface

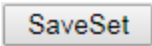
1. Click Function Keys → Line Key.
2. Select the wanted Line Key.
3. Enter intercom codes followed by desired number in the Value field.
4. Select the Account ID
5. Click the  button to save the configuration.

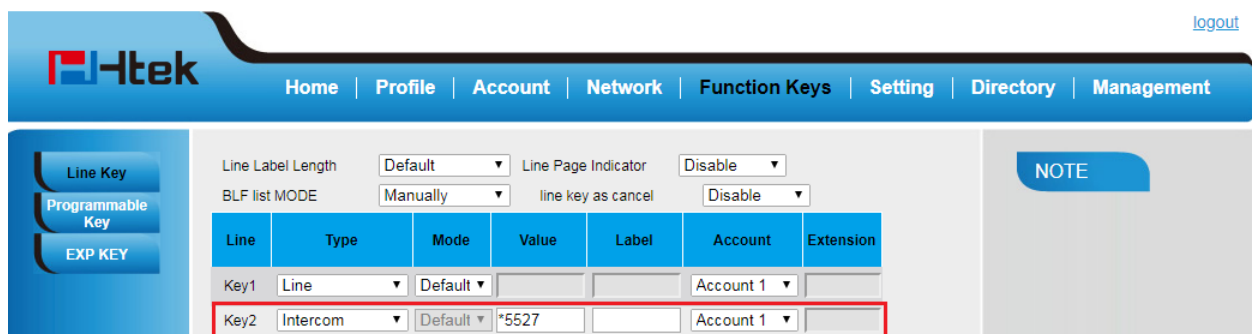

The screenshot shows the Htek web interface. The top navigation bar includes 'Home', 'Profile', 'Account', 'Network', 'Function Keys', 'Setting', 'Directory', and 'Management'. The left sidebar has 'Line Key', 'Programmable Key', and 'EXP KEY' options. The main content area shows configuration options for 'Line Key'. A table lists keys: 'Key1' (Line, Default, Account 1) and 'Key2' (Intercom, Default, *5527, Account 1). The 'Key2' row is highlighted with a red box. A 'SaveSet' button is visible at the bottom of the configuration area.

If you want to achieve the intercom feature, you must enable the “Allow Auto Answer by Call-Info”

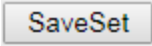
1. Click Profile
2. Select the desired profile from the pull-down list of Profile in the Profile field.
3. Click Advanced
4. Enable the “Allow Auto Answer By Call-Info”
5. Click the  button to save the configuration.

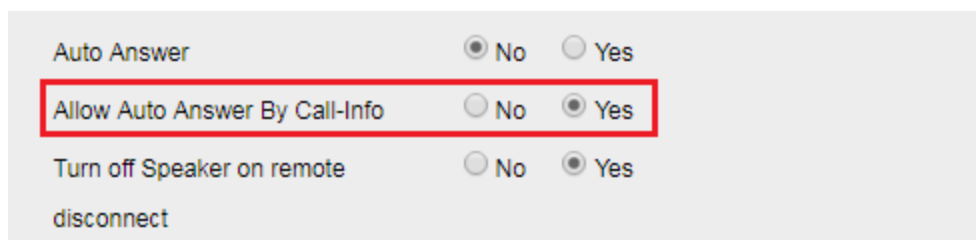

The screenshot shows the 'Auto Answer' configuration section. It includes radio buttons for 'No' and 'Yes' for 'Auto Answer', 'Allow Auto Answer By Call-Info', and 'Turn off Speaker on remote disconnect'. The 'Allow Auto Answer By Call-Info' option is checked to 'Yes' and highlighted with a red box.

Note:
This feature is not available on all servers. For more information, contact your system administrator.

Intercom Barge

If this option is enabled, when there is an active call and an incoming intercom call arrives,

the previous call will be put on hold and the intercom call will be answered

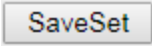
1. Click the Setting → Preference
2. Set On or Off for Intercom Barge.
3. Click  for the setting.

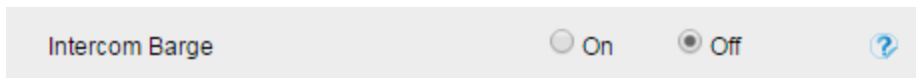

Note:

This feature is not available on all servers. For more information, contact your system administrator.

DTMF

When the key is configured as DTMF key, you are allowed to send out the desired DTMF number during the conversation.

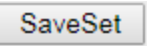

To use this feature, you should sure that the DTMF Tone is on.

To configure the DTMF via Web interface

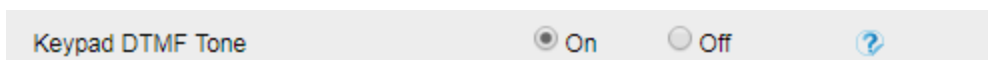
1. Click Setting → Preference
2. Select On for Keypad DTMF Tone.
3. Click  to save the configuration.



To configure the DTMF via Phone interface

1. Press Menu → Features → Function Keys → Line Keys as Function Keys → Line Key2(for example)
2. Press  and  key to select the DTMF in the Type field.
3. Enter the value with the Desired DTMF number
4. Press  or Save soft key to save the configuration

To configure the DTMF via Web interface

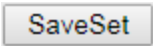

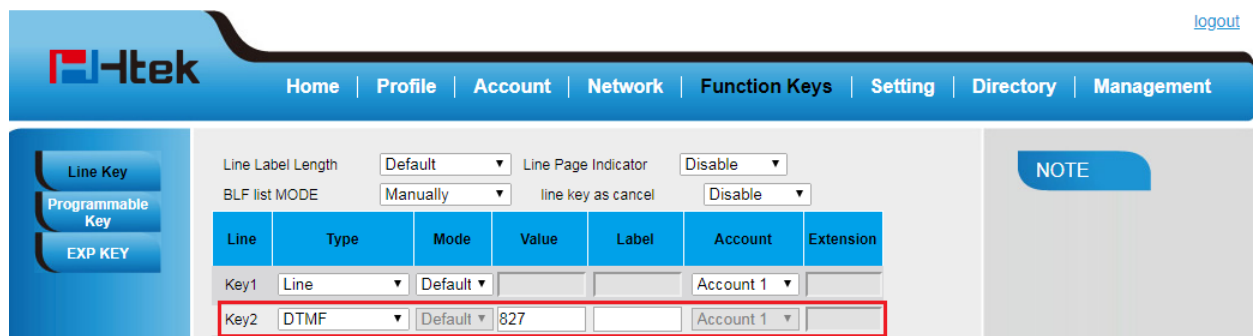
1. Click Function Keys → Line Key.
2. Select the desired Line Key and select DTMF in the Type.
3. Fill the value with the Desired DTMF number.
4. Click the  to save the configuration.



Prefix

If the key is configured as Prefix key, you can set the number prefix (e.g. Before the number plus 9), then you don't input 9, press the key and 9 will display on the LCD interface.

To configure the Prefix via Phone interface

1. Press Menu → Features → Function Keys → Line Keys as Function Keys → Line Key2(for example)
2. Press  and  key to select the Prefix in the Type field.
3. Enter the value with number that you want to set as prefix
4. Press  or Save soft key to save the configuration

To configure the Prefix via Web interface

1. Click Function Keys → Line Key.

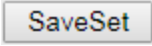
2. Select the desired Line Key and select Prefix in the Type.
3. Fill the value.
4. Click  to save the configuration.

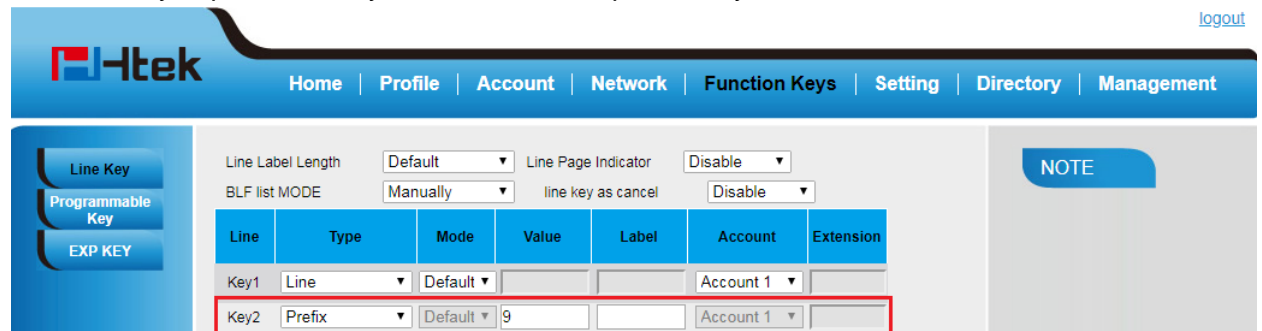

Then when you press this key, the set value is input directly.



Local Group

When use the Local Group feature, press the key and enter the local Contacts interface quickly.

To configure the Local group via Phone interface

1. Press Menu → Features → Function Keys → Line Keys as Function Keys → Line Key2(for example)
2. Press  and  key to select the Local Group in the Type field.
3. Press  or Save soft key to save the configuration

To configure the Local Group via Web interface

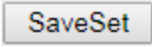
1. Click Function Keys → Line Key.
2. Select the desired Key and select Local Group in the Type.
3. Click  to save the configuration.

Then you can press the local group key to quickly access the pre-defined contact group in

the local directory.

The screenshot shows the Htek web interface with the 'Function Keys' menu selected. On the left, there are buttons for 'Line Key', 'Programmable Key', and 'EXP KEY'. The main content area has several settings: 'Line Label Length' (Default), 'Line Page Indicator' (Disable), 'BLF list MODE' (Manually), and 'line key as cancel' (Disable). Below these is a table with columns: Line, Type, Mode, Value, Label, Account, and Extension. The table has two rows: 'Key1' with 'Line' type and 'Key2' with 'Local Group' type. The 'Key2' row is highlighted with a red border. A 'NOTE' box is visible on the right.

XML Group

When use the XML Group feature, press the key and enter the Remote Contacts interface quickly.

To configure the XML group via Phone interface

1. Press Menu → Features → Function Keys → Line Keys as Function Keys → Line Key2 (for example)
2. Press and key to select the XML Group in the Type field.
3. Press and key to select the Account ID.
4. Press or Save soft key to save the configuration

To configure the XML Group via Web interface



1. Click Function Keys → Line Key.
2. Select the desired Key and select XML Group in the Type.
3. Select the Account.
4. Click to save the configuration.

This screenshot is similar to the one above, but the 'Type' field for 'Key2' is now set to 'XML Group'. The 'Key2' row remains highlighted with a red border. The rest of the interface, including the navigation menu and settings, is identical to the previous screenshot.

LDAP

When use the LDAP feature, you can get the LDAP Phonebook directly.

To configure the LDAP via Phone interface

1. Press Menu → Features → Function Keys → Line Keys as Function Keys → Line Key2(for example)
2. Press  and  key to select the LDAP in the Type field.
3. Press  or Save soft key to save the configuration

To configure the LDAP via Web interface

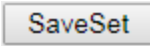
1. Click Function Keys → Line Key.
2. Select the desired Key and select LDAP in the Type.
3. Click  to save the configuration.

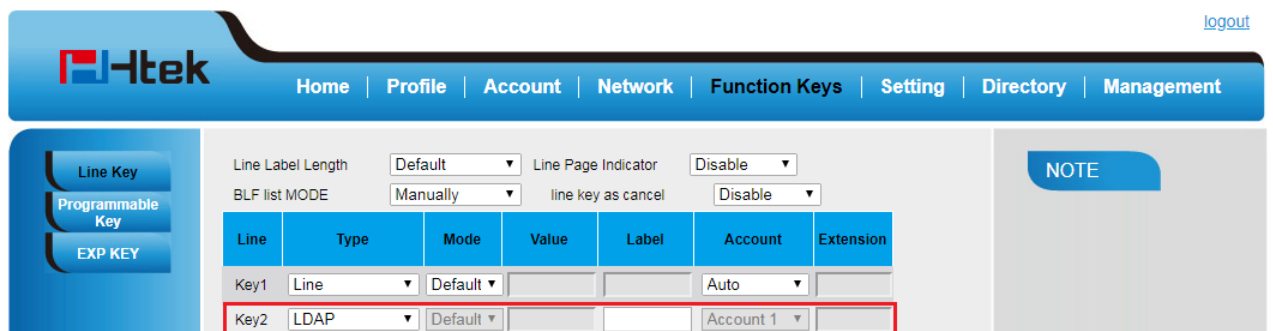



Line	Type	Mode	Value	Label	Account	Extension
Key1	Line	Default			Auto	
Key2	LDAP	Default			Account 1	

XML Browser

You can use this key feature to access the Xml browser quickly. The Xml browser allows you to create custom services which meet your functional requirements on the server. You can customize practical applications, such as weather report, stock information, Google search, etc.

To configure the XML Browser via Phone interface

1. Press Menu →Features →Function Keys →Line Keys as Function Keys → Line Key2(for example)
2. Press  and  key to select the XML Browser in the Type field.
3. Filled the access URL for xml browser
4. Press  or Save soft key to save the configuration

To configure the XML Browser via Web interface

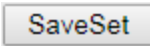

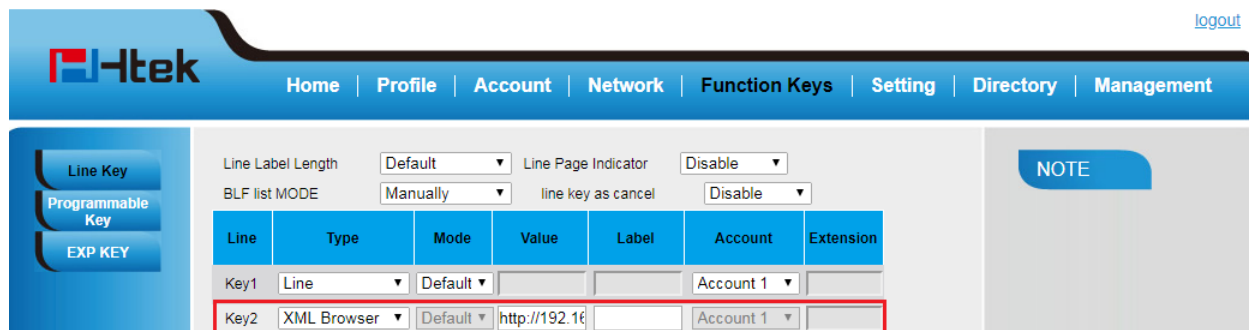
1. Click Function Keys → Line Key.
2. Select the desired Key and select xml browser in the Type.
3. Filled the access URL for xml browser (e.g.: <http://192.168.0.106/XMLBrowser/TextMenu.xml>)
4. Click  button to save the configuration.



Broadsoft Group

When using the BroadSoft Group feature, by just pressing the key you can enter the Broadsoft Contacts interface its fast and convenient.

To configure the Broadsoft group via Phone interface

1. Press Menu →Features →Function Keys →Line Keys as Function Keys → Line Key2(for example)
2. Press  and  key to select the Broadsoft Group in the Type field.

3. Press  or Save soft key to save the configuration

To configure the Broadsoft group via Web interface

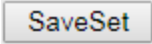

1. Click Function Keys → Line Key.
2. Select the desired Key and select Broadsoft group in the Type.
3. Click the  button to save the configuration.

Conference

The Htek IP Phone supports up to 5-way conference. You are allowed to configure the

programmable key to be used as a conference key. This key works same as .

To configure the Conference via Phone interface

1. Press Menu → Features → Function Keys → Line Keys as Function Keys → Line Key2(for example)
2. Press  and  key to select the Conference in the Type field.
3. Press  or Save soft key to save the configuration

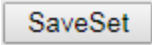

To configure Conference via Web interface

1. Click Function Keys → Line Key.
2. Select the desired Key and select Conference in the Type.
3. Click the  button to save the configuration.

Forward

If the key is configured as Forward key, press this key under the idle status, the IP phone will turn to the Always Forward interface and you can set the Forward to number, then when there is any call to that number it will be forwarded to the set number automatically.

To configure the Forward via Phone interface

1. Press Menu →Features →Function Keys →Line Keys as Function Keys → Line Key2(for example)
2. Press  and  key to select the Forward in the Type field.
3. Enter the Number to forward to.
4. Press  or Save soft key to save the configuration

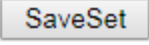

To configure Forward via Web interface

1. Click Function Keys →Line Key.
2. Select the desired Key and select Forward in the Type.
3. Enter the Value with the number you want to forward to.
4. Click the  button to save the configuration.

Transfer

You are able to configure the key as a transfer key to perform the Attended/Semi-Attended Transfer.

To configure the Transfer via Phone interface

1. Press Menu →Features →Function Keys →Line Keys as Function Keys → Line Key2(for example)
2. Press  and  key to select the Transfer in the Type field.

3. Enter the Number to transfer to
4. Press  or Save soft key to save the configuration

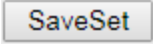

To configure Transfer via Web interface

1. Click Function Keys →Line Key.
2. Select the desired Key and select Transfer in the Type.
3. Enter the Value with the number that wanted transfer to
4. Click the  button to save the configuration.

Hold

The key can be configured as a hold key. You can use this key to hold and resume a call during the conversation.

To configure the Hold via Phone interface

1. Press Menu →Features →Function Keys →Line Keys as Function Keys → Line Key2(for example)
2. Select the wanted Line Key.
3. Press  and  key to select the Hold in the Type field.
4. Press  or Save soft key to save the configuration

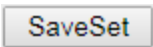

To configure Hold via Web interface

1. Click Function Keys →Line Key.
2. Select the desired Key and select Hold in the Type.
3. Click the  button to save the configuration.

Group Listening

With this feature, when you have an active call, you can listen using Handset and Free-speaker, but only can use the handset to speak.

To configure the Group listening via Phone interface

1. Press Menu →Features →Function Keys →Line Keys as Function Keys → Line Key2(for example)
2. Press  and  key to select the Group Listening in the Type field.
3. Press  or Save soft key to save the configuration

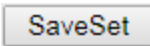

To configure Group listening via Web interface

1. Click Function Keys →Line Key.
2. Select the desired Key and select Group Listening in the Type.
3. Click  to save the configuration.

DND

If the key is configured as DND key, allows you to activate the DND function immediately when you press it and the phone will reject all incoming calls automatically. Press it again to deactivate DND mode.

To configure the DND via Phone interface

1. Press Menu →Features →Function Keys →Line Keys as Function Keys → Line Key2(for example)
2. Press  and  key to select the DND in the Type field.
3. Press  or Save soft key to save the configuration

To configure DND via Web interface

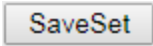
1. Click Function Keys →Line Key.
2. Select the desired Key and select DND in the Type.
3. Click the  button to save the configuration.

To enable DND feature

Press the DND soft key when the phone is idle status, and then DND icon shown on the LCD.

To disable DND feature

Press the DND soft key again, then there is no DND icon on the LCD.

Redial

If the key is configured as Redial key, you can redial the last placed call from the IP Phone.

To configure Redial via Web interface

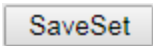
1. Click Function Keys →Line Key
2. Select the desired Key and select Redial in the Type.
3. Enter the Label displayed on LCD.
4. Click the  button to save the configuration.

SMS

Send SMS

To send SMS via Web interface

1. Click Setting→ SMS
2. Select the Account (from which account the SMS sent)

3. Enter the target number
4. Input the content of SMS, and click Send.

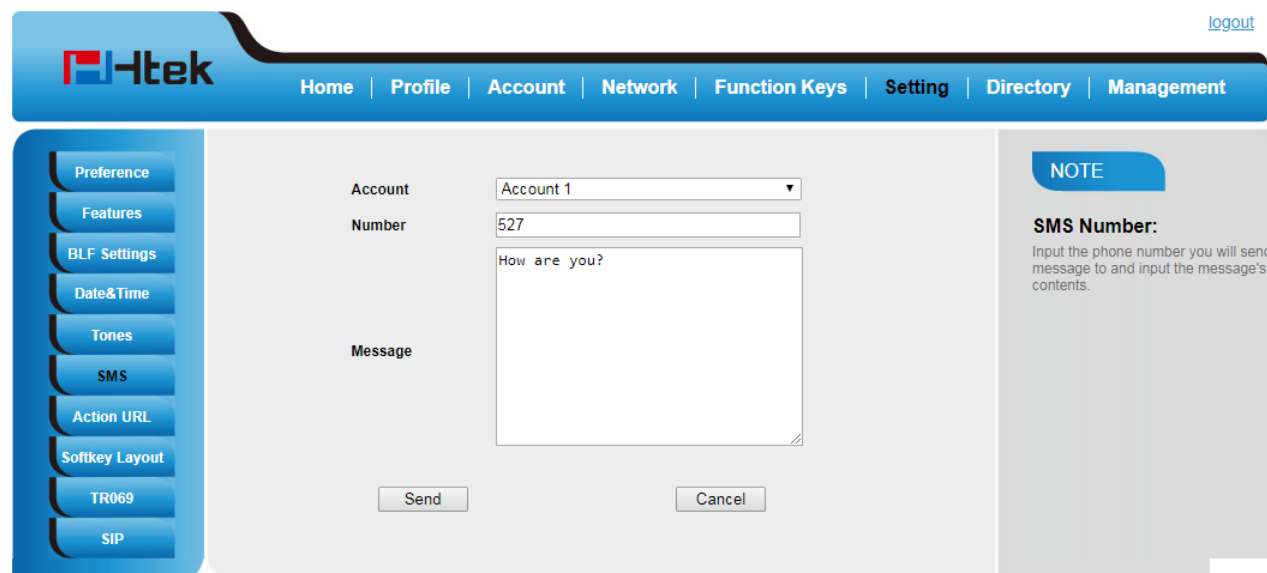



To send SMS via Phone interface :

1. Click Menu→ Messages→ Text Message→ Set SMS
2. Enter the contents in the white field.
3. Press the Send button
4. Select the account in the From field (from which account the SMS sent)
5. Enter the target number in the To field (to which account the number sent)
6. Press the Send button.

Set SMS Line Key

To configure the SMS via Phone interface

1. Press Menu →Features →Function Keys →Line Keys as Function Keys → Line Key2(for example)
2. Press  and  key to select the SMS in the Type field.

3. Press  or Save soft key to save the configuration

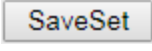

To configure SMS via Web interface

1. Click Function Keys →Line Key.
2. Select the desired Key and select SMS in the Type.
3. Click  to save the configuration.

Record

With record feature, you can record your calls by pressing the record key .

To configure the record via Phone interface

1. Press Menu →Features →Function Keys →Line Keys as Function Keys → Line Key2(for example)
2. Press  and  key to select the Record.
3. Press  or Save soft key to save the configuration

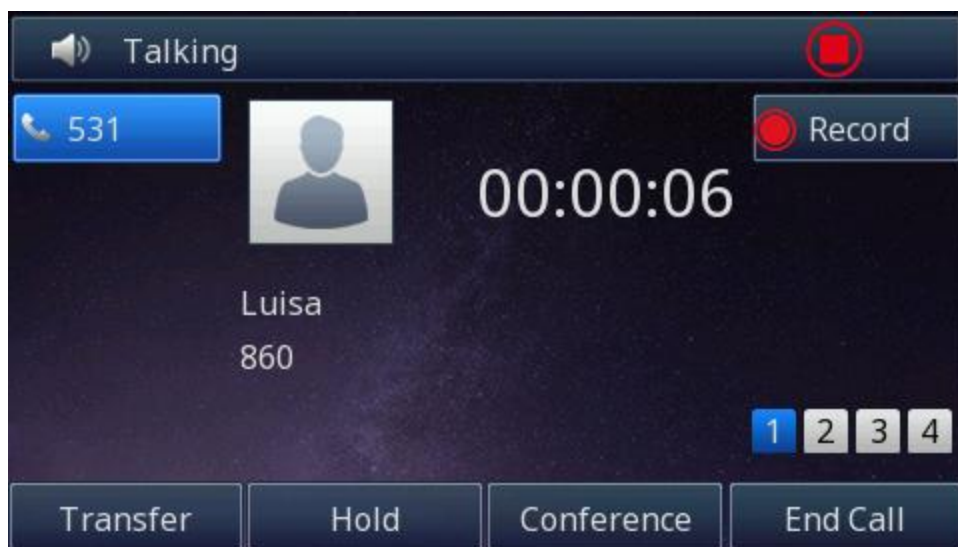

To configure the record via Web interface

1. Click Function Keys → Line Key.

2. Select the desired Line Key and select Record in the Type.

3. Click the  button to save the configuration.

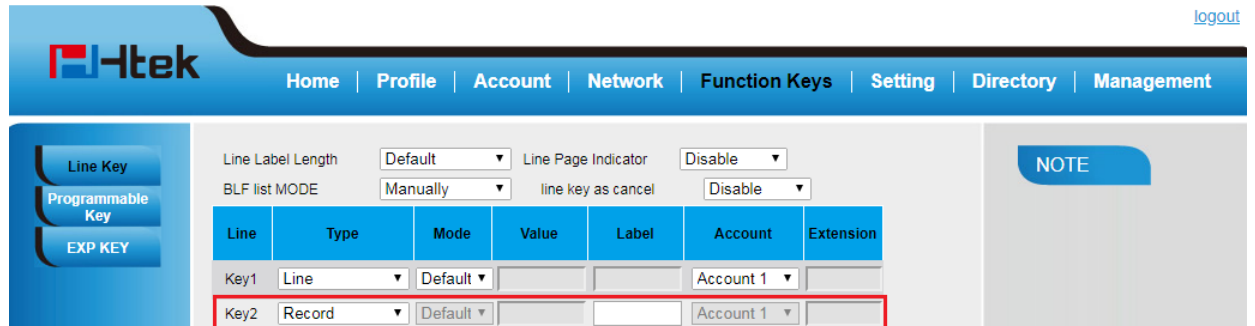



Note:
Please contact the system administrator whether support this feature or not.

URL Record

The phone sends HTTP URL request to trigger a recording. Contact your system administrator for the predefined URL.

To configure the URL record via Phone interface

1. Press Menu → Features → Function Keys → Line Keys as Function Keys → Line Key2 (for example)
2. Press  and  key to select the URL Record.
3. Press  or Save soft key to save the configuration



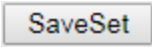

To configure the record via Web interface

1. Click Function Keys → Line Key.
2. Select the desired Line Key and select URL Record in the Type.
3. Click the  button to save the configuration.

Paging

With this feature, you can call a paging group directly.

To configure the paging via Phone interface

1. Press Menu → Features → Function Keys → Line Keys as Function Keys → Line Key2(for example)
2. Press  and  key to select the Paging.
3. Enter the paging code followed the number.
4. Press  and  key to select the Account ID.
5. Press  or Save soft key to save the configuration

To configure the Paging via Web interface

1. Click Function Keys → Line Key.
2. Select the desired Line Key and select Paging in the Type.
3. Enter the paging code followed the number.
4. Select the Account.
5. Click the  button to save the configuration.

Shared Line

Htek IP Phone supports “Shared Call Appearance” by Broadsoft and XCast standard. This feature allows members of the SCA group to shared SIP lines and provides status monitoring (idle, active, progressing, hold) of the shared line. When there is an incoming call designated for the SCA group, all of the members of the group will be notified of an incoming call and will be able to answer the call from the phone with the SCA extension registered in the group.

All the users that belong to the same SCA group will be notified by visual indicator when a





user seizes the line and places an outgoing call, and all the users of this group will not be able to seize the line until the line goes back to an idle state or when the call is placed on hold (with the exception of when multiple call appearances are enabled on the server side).

In the middle of the conversation, there are two types of hold: Public Hold and Private Hold. When a member of the group places the call on public hold, the other users of the SCA group will be notified of this by the red-flashing button and they will be able to resume the call from their phone by pressing the line button. However, if this call is placed on private-hold, no other member of the SCA group will be able to resume that call.

To enable shared call appearance, the user would need to register the shared line account on the phone. In addition, they would need to navigate to “Account” -> “Advanced” on the webpage and set the line to “Shared Line” and “SIP Server Type”, and configure the line key or Line Key as “line” type with the desired account on webpage or LCD. If the user requires more shared call appearances, the user can configure multiple line keys (Function Keys->Line key) to be “line” type associated with the account.

This feature is very useful in the boss and secretary scenario. For example, the secretary can share the boss' extension number on her phone. When there is an incoming call to the extension number of the boss, both the phones of the boss and the secretary will ring simultaneously. Either the boss or the secretary can answer the call. Calls on shared line can be placed on hold or barged in.

To configure the line key as line via Phone interface

1. Press Menu →Features →Function Keys →Line Keys as Function Keys → Line Key2(for example)
2. Press  and  key to select the Line in the Type field.
3. Press  and  key to select the Account ID.
4. Enter the Label
5. Enter the Value
6. Press  or Save soft key to save the configuration

To configure the line key as line via Web interface

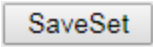
1. Click Function Keys → Line Key.
2. Select the desired Line Key and select Line in the Type.
3. Enter the Value.
4. Enter the Label.
5. Select the Account ID
6. Click the  button to save the configuration and then restart.



Note:

This feature is not available on all servers. For more information, contact your system administrator.

Public Hold

The key can be configured as a public hold key. During a conversation, all members belonging to that particular SLA group can use this key to hold or resume a call.

To configure the Public hold via Phone interface

1. Press Menu → Features → Function Keys → Line Keys as Function Keys → Line Key2(for example)
2. Press  and  key to select the Public Hold.
3. Press  or Save soft key to save the configuration

To configure public hold via Web interface

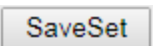
1. Click Function Keys → Line Key.
2. Select the desired Key and select Public Hold in the Type.
3. Click the  button to save the configuration.

Private Hold

The key can be configured as a private hold key. During a conversation, all members belonging to that particular SLA group can use this key to hold the call, but only the initiator can resume the call.

To configure the Private hold via Phone interface

1. Press Menu → Features → Function Keys → Line Keys as Function Keys → Line Key2(for example)
2. Press and key to select the Private Hold.
3. Press or Save soft key to save the configuration

To configure private hold via Web interface



1. Click Function Keys → Line Key.
2. Select the desired Key and select Private Hold in the Type.
3. Click the button to save the configuration.

Hot Desking

Hot Desking originates from the definition of being the temporary physical occupant of a work station or surface by a particular employee. A primary motivation for Hot Desking is cost reduction. This feature is regularly used in places where all employees are not in the office at the same time, or not in the office for a very long time, which means their personal offices are often vacant, consuming valuable space and resources.

You can use Hot Desking on the IP phone to logout the existing accounts and then log in a new account, which allows many users to share the phone resource in different times. To use this feature, first you need to configure a Hot Desking key in the advance settings. This feature is supported on the version 1.0.3.82 or later

To configure the hot desking via Phone interface

1. Press Menu →Features →Function Keys →Line Keys as Function Keys → Line Key2(for example)
2. Press  and  key to select the Hot Desking.
3. Enter the display name in the Label field.
4. Press  or Save soft key to save the configuration

To configure the hot desking via Web interface :

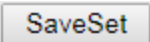
1. Click Function Keys →Line Key.
2. Select the desired Key and select Hot Desking in the Type.
3. Select the desired account from the pull-down list of Account field.
4. Click the  button to save the configuration.

To use the Hot desking feature on the user interface :

1. Press the Hot desking key when the IP Phone is idle.
2. Enter the Extension number and password
3. Click Save soft key

You can see the account information which has changed.



Note:

This feature is not available on all servers. For more information, contact your system administrator.

ACD

ACD feature is often used in offices for customer service, such as call center. The ACD system handles large volumes of incoming calls from callers who have no need to talk to a specific person but who require assistance from any of the different personnel at the earliest point. The ACD feature on the Htek IP Phone allows the ACD system to distribute calls from large volumes of incoming calls to the registered IP phone users. To use this feature, first you should configure an ACD key in the advance settings.

To configure the ACD via Phone interface

1. Press Menu →Features →Function Keys →Line Keys as Function Keys → Line Key2(for example)
2. Press  and  key to select the ACD.
3. Enter the label in the Label field.
4. Select the desired account in the Account ID field.
5. Press  or Save soft key to save the configuration

To configure the ACD via Web interface:

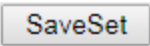
1. Click Function Keys →Line Key.
2. Select the desired Key and select ACD in the Type.
3. Enter the label in the Label field.
4. Select the desired account from the pull-down list of Account field.
5. Click the  button to save the configuration.



Note:

This feature is not available on all servers. For more information, contact your system administrator.

Zero Touch

You can use this key feature to configure auto provision and network parameters quickly. This feature is supported on the version 1.0.3.82 or later

To configure the zero touch via Phone interface

1. Press Menu →Features →Function Keys →Line Keys as Function Keys → Line Key2(for example)
2. Press  and  key to select the Zero Touch
3. Press  or Save soft key to save the configuration

To configure the zero touch via Web interface :

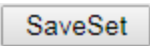
1. Click Function Keys →Line Key.
2. Select the desired Key and select Zero Touch in the Type.
3. Click the  button to save the configuration.

To use the zero touch feature on the user interface :

1. Press the Zero Touch key when the IP Phone is idle.
2. Press the OK soft key and the IP Phone will enter the WAN Port interface; you can change the WAN Type by pressing the Navigation keys.
3. Press the Next soft key to enter Network interface, then you can configure some information.
4. Press the Next soft key again, you can configure auto provision information.
5. When you finish the setting, you can press the OK to accept the changes.

Note :



This feature is not available on all servers. For more information, contact your system administrator.

Multicast Paging

You can use multicast paging to quickly and easily forward out time sensitive announcements to people within the multicast group. You can configure a multicast paging key or a paging list key on the phone, which allows you to send a Real Time Transport Protocol (RTP) stream to the pre-configured multicast address/addresses without involving SIP signaling. You can configure the phone to receive an RTP stream from pre-configured multicast listening address/addresses without involving SIP signaling. You can specify up to 10 multicast listening addresses.

Sending RTP Stream

To configure a multicast paging key via Phone interface

1. Press Menu → Feature → Line Key → Line Key2 (e.g.)
2. Press  and  or switch key to select the Multicast Paging in the Type field.
3. Enter the multicast IP address and port number (e.g., 224.5.6.20:2000) in the Value field.
4. The valid multicast IP addresses range from 224.0.0.0 to 239.255.255.255.
5. Press  or Save soft key to save the configuration

To configure a multicast paging key via Web interface

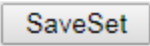
1. Function Keys->Line key :
2. Select the desired Key and select Multicast Paging in the Type.
3. Enter the multicast IP address and port number (e.g., 224.5.6.20:2000) in the Value field.
The valid multicast IP addresses range from 224.0.0.0 to 239.255.255.255.
4. Click the  button to save the configuration.

Sending RTP Stream:

Press the multicast paging key when the phone is idle.

The phone sends RTP to a preconfigured multicast address (IP: Port). Any phone in the

local network then listens to the RTP on the preconfigured multicast address (IP:Port). For both sending and receiving of the multicast RTP, there is no SIP signaling involved. The multicast paging key LED illuminates solid green.

Receiving RTP Stream

You can configure the phone to receive a Real Time Transport Protocol (RTP) stream from the pre-configured multicast address/addresses without involving SIP signaling. You can specify up to 10 multicast addresses that the phone listens to on the network.

How the phone handles incoming multicast paging calls depends on Paging Barge and Paging Priority Active parameters configured via web user interface.

Paging Barge

The paging barge parameter defines the priority of the voice call in progress. If the priority of an incoming multicast paging call is lower than that of the active call, it will be ignored automatically. If Disabled is selected from the pull-down list of Paging Barge, the voice call in progress will take precedence over all incoming multicast paging calls.

Valid values in the Paging Barge field:

- 1 to 10: Define the priority of the active call, 1 with the highest priority, 10 with the lowest.
- Disabled: The voice call in progress will take precedence over all incoming paging calls.

Paging Priority Active

The paging priority active parameter decides how the phone handles incoming multicast paging calls when there is already a multicast paging call on the phone. If enabled, the phone will ignore incoming multicast paging calls with lower priorities, otherwise, the phone will answer incoming multicast paging calls automatically and place the previous multicast paging call on hold. If disabled, the phone will automatically ignore all incoming multicast paging calls.

Multicast Codec:

You can only configure the codec via Web interface.

To configure multicast codec key via Web interface

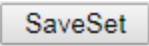
1. Click Directory ->Multicast Paging:
2. Select the desired codec from the pull-down list of Multicast Codec
3. Click the  button to save the configuration.

To configure multicast listening addresses via Web interface:

1. Click Directory->Multicast paging.
2. Select the desired value from the pull-down list of Paging Barge.
3. Select the desired value from the pull-down list of Paging Priority Active.
4. Enter the multicast IP address/addresses and port number (e.g., 224.5.6.20:2000) which the phone listens to for incoming RTP multicast in the Listening Address field.
5. Enter the label in the Label field.

6. Click button to save the configuration.

[logout](#)

Home | Profile | Account | Network | Function Keys | Setting | Directory | Management

Directory
Remote Phone Book
Call History
LDAP
Network Directory
MultiCast Paging

Paging Barge: 10
Paging Priority Active: Enable
Multicast Codec: PCMU

Index	Listening Address	Label	Multi Priority
IP Address 1	224.5.6.20:2000	test1	1
IP Address 2			2
IP Address 3			3
IP Address 4			4
IP Address 5			5
IP Address 6			6
IP Address 7			7
IP Address 8			8
IP Address 9			9
IP Address 10			10

NOTE

Note:

The priorities of listening to multicasting addresses can be predefined: 1 being the highest priority, 10 with the lowest in priority order. Both the multicast paging sender and receiver's phones play a warning tone when establishing a multicast paging call. Listening to Multicasting addresses can be configurable via Web interface only.

BT Feature

Htek IP Phone Model UC926E supports the Bluetooth feature.

The Model UC926E connects to a wide range of Bluetooth Headset, compatible with Bluetooth specification V4.0 and backwards compatible with 1.1, 1.2, 2.0 and 3.0.

How to Enable headset mode?

To configure the headset mode via Phone interface:

- Find Menu then navigate as follows:
Menu->Settings->Basic Setting->Headset:

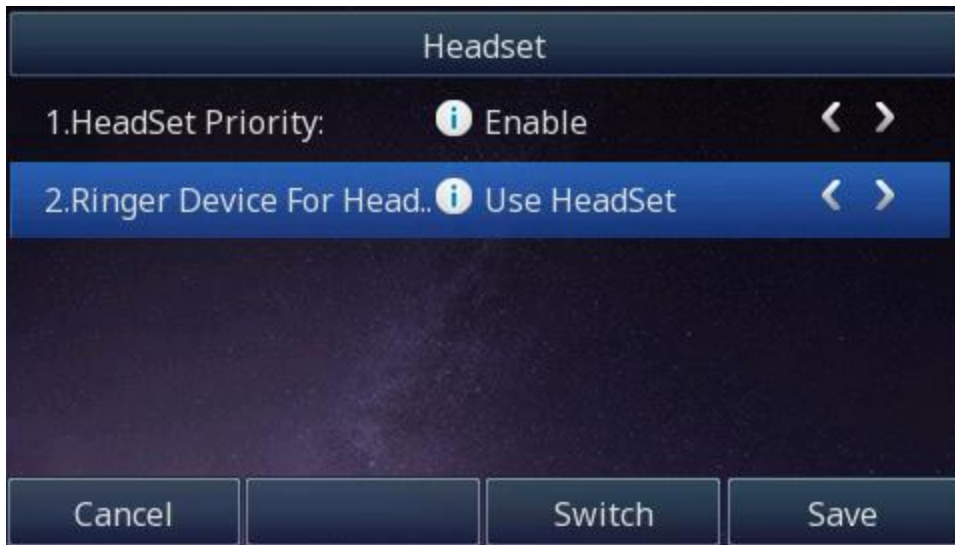

2. Enable the Headset Priority
3. Choose the “Use HeadSet” or “Speaker&Headset” from “Ringer Device For Headset” option
4. Press the save button to save the configuration.

To configure the headset mode via Web interface:

1. Login the phone’s webpage (**Username**: admin, **Password**: admin)
2. Setting->Preference. Enable the Headset priority. Choose the “Use HeadSet” or “Speaker&Headset” from “Ringer Device For Headset” option.

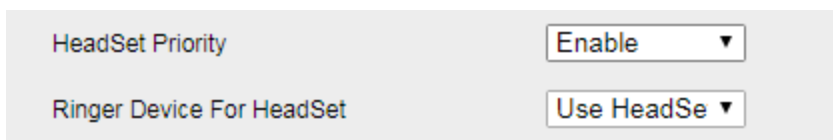

3. Click the “SaveSet” button to save the configuration

To enable the headset mode:

1. Press the headset key on phone’s during the idle status when you accomplish the above-mentioned configuration.
2. Headset icon will display on phone status bar.



How to Activate Bluetooth?

To activate Bluetooth via Phone interface:

1. Find Menu then navigate as follows:
Menu->Settings->Basic Setting->Bluetooth:



2. Press the save button to save the configuration
3. You will see the Bluetooth icon on phone's homepage status bar during the idle status.
(This icon means that phone has no pair the Bluetooth device)



How to Pair the Bluetooth Headset to the Phone?

Open the Bluetooth pairing mode on Bluetooth headset:

- 1) Turn on the Bluetooth headset.
- 2) Long press the multifunction key on the Bluetooth headset until the indicator LED alternately flashes red and blue.
The Bluetooth headset is in pairing mode.

How to scan the Bluetooth headset device on phone interface:

1. Select "Paired Bluetooth Device". Press the "Scan" button on phone interface:



2. The phone will enter the scan interface.

The phone starts searching for Bluetooth headsets within the working range of 10 meters (32 feet).

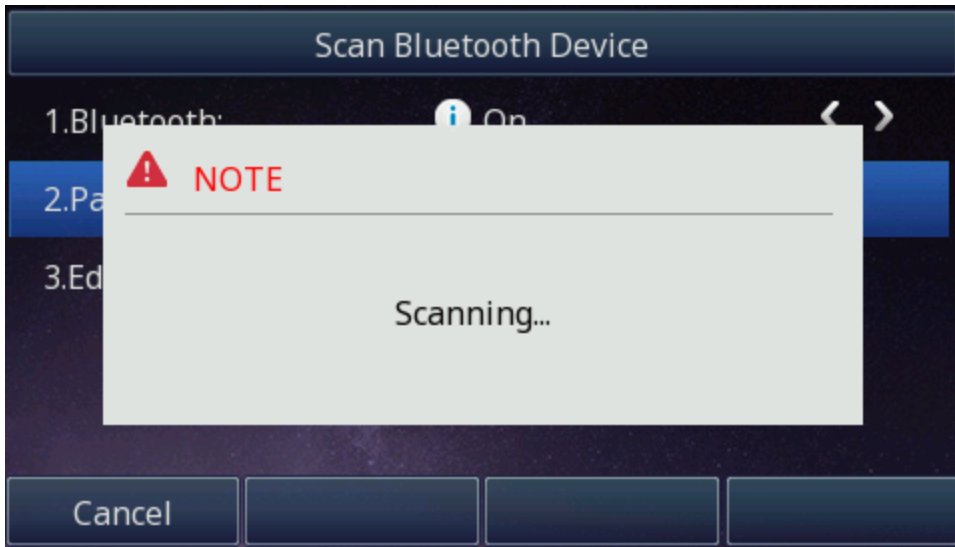

3. All detected Bluetooth headsets will display on the phone:

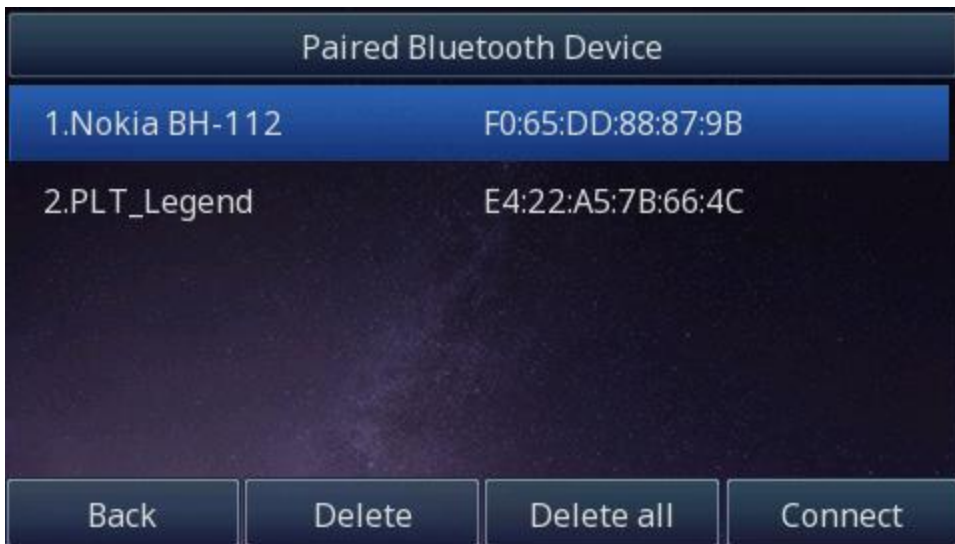

4. Choose the desired Bluetooth Device from the list and connect to it:

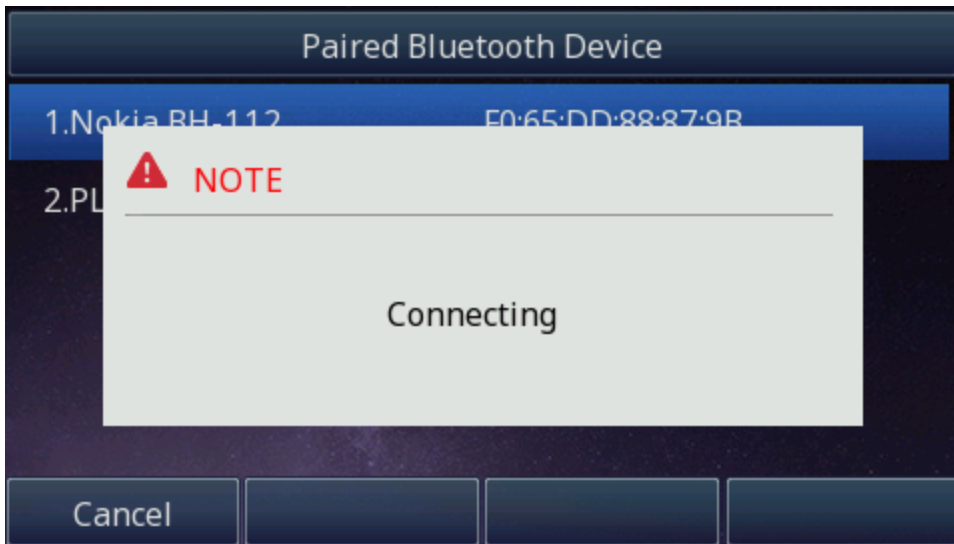

5. If the Bluetooth Device is connected/paired successfully, you will see the “Connect Success!” and connected successfully icon;

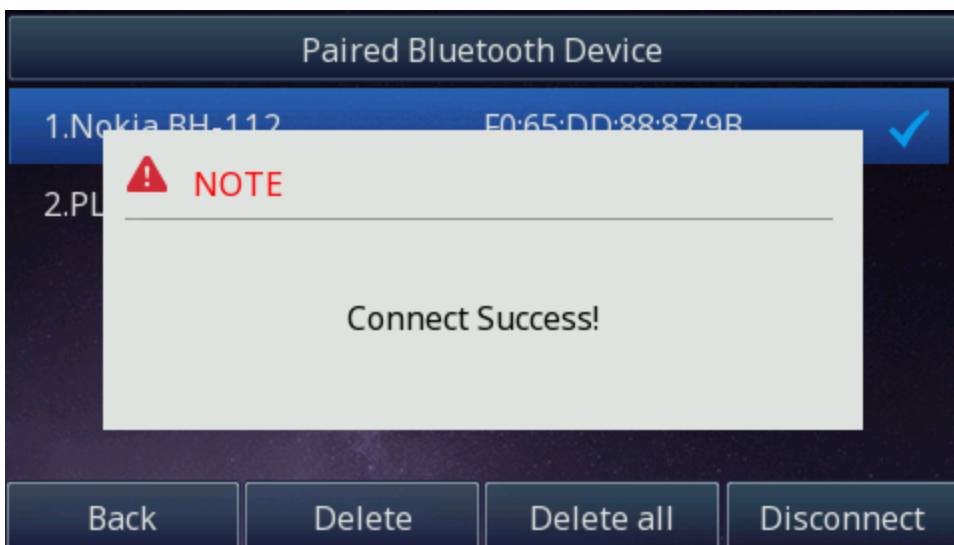



If you want to disconnect with this Bluetooth device, you can press the "Enter" button, then press the "Disconnect" button.

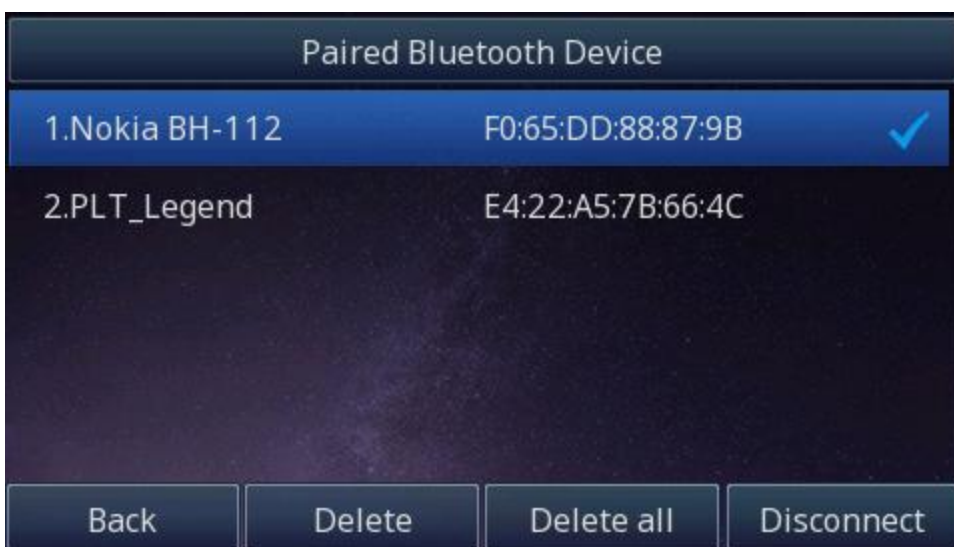
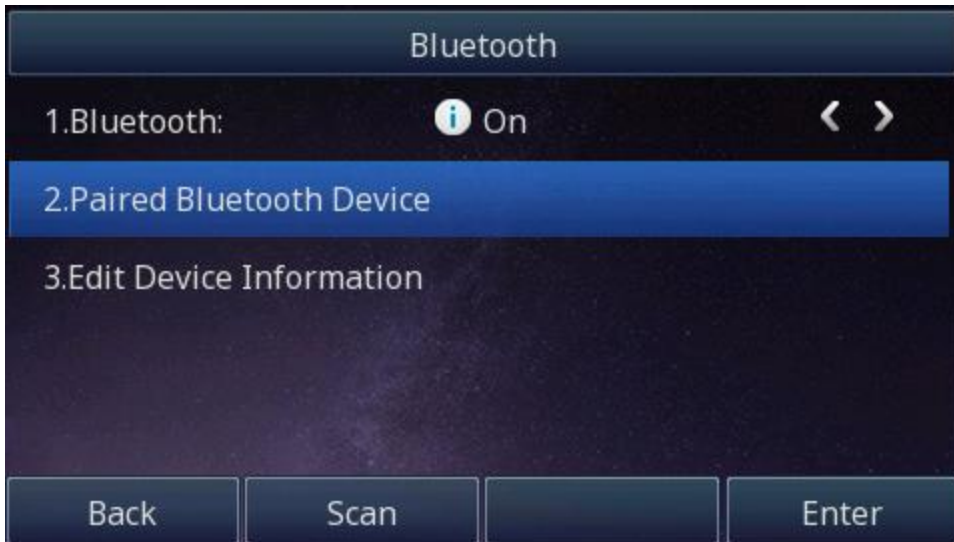



If you want to delete the Bluetooth device, please press the “Delete” or “Delete all” button, then Bluetooth device will be deleted.

- When you back to idle interface, you will see the connected successfully icon:



How to edit device information?

How to edit device information on phone interface:

- Find Menu then navigate as follows:
Menu->Settings->Basic Setting->Bluetooth: Edit Device Information.

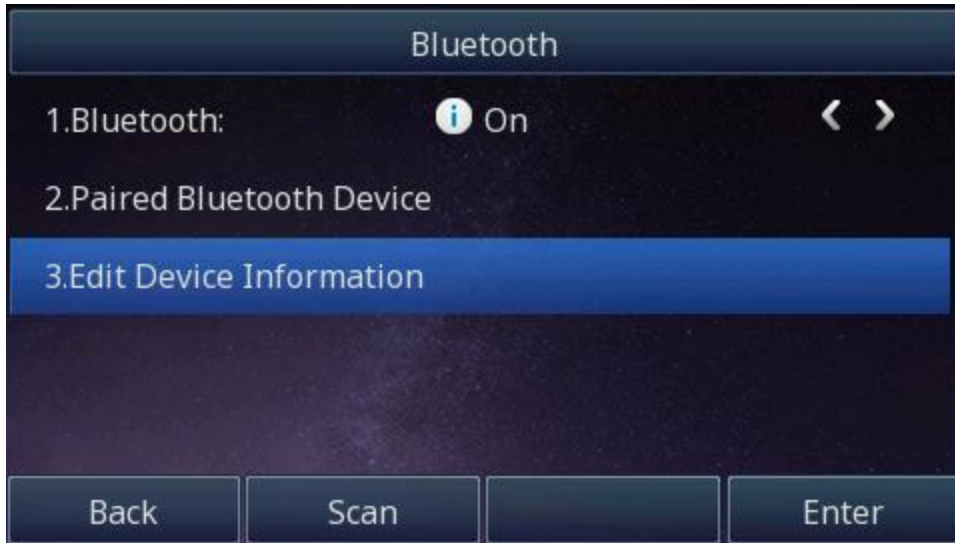

2. Press the enter button, you can edit the Device Name:

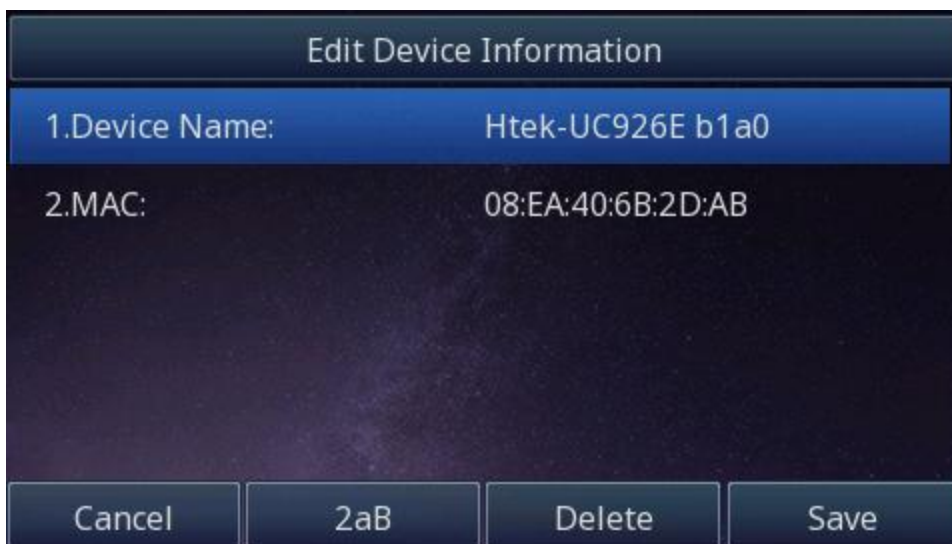

Note:

The phone must be in the headphone mode to normally use the Bluetooth function.

Answering Calls

How to answer an incoming call?

With the Bluetooth headset paired, press the multifunction key on the Bluetooth headset to answer an incoming call.

How to adjust the earphone volume during a call?

With the Bluetooth headset paired, you can do the following:

- Press the Volume key (+) on the Bluetooth headset to increase the volume.
Press the Volume key (-) on the Bluetooth headset to decrease the volume.
- Press the Volume key (+) on the phone to increase the volume.
Press the Volume key (-) on the phone to decrease the volume.

How to Ending Calls?

To end a call:

With the Bluetooth headset paired, press the multifunction key on the Bluetooth headset to end a call.

WIFI Feature

Our new model UC926E supports the Wi-Fi feature which allows users to experience the flexible deployment. When the Wi-Fi feature is enabled, the IP phone will automatically scan the available wireless networks. All the available wireless networks will display in scanning list on the LCD screen. The Wi-Fi feature can be configured in two different ways: Manual and Provision.

Manual

Wifi can be manually configured by phone, so that users can add wifi according to their own situation.

How to Enable Wi-Fi feature of the UC926E?

Enabling Wi-Fi feature via Phone interface:

1. Find Menu then navigate as follows
Menu->Settings->Basic Setting->Wi-Fi.
Press the Switch button to switch to the Manual Mode and enter.



2. Press the Switch button to turn on Wi-Fi feature.



3. Press the Save button to save the configuration.



How to Connect the UC926E To an Available Wireless Network?

Connect to an available wireless network via Phone interface:

1. Find Menu then navigate as follows
Menu->Settings->Basic Setting->Wi-Fi: Available Network(s)



2. Press the Enter button, you will see many available wireless networks:



3. You can press the "scan" button to scan the wireless network
4. You can press the "Detail" button to view a wireless network's detail information.
5. Choose desired wireless network and then press the "Connect" button:

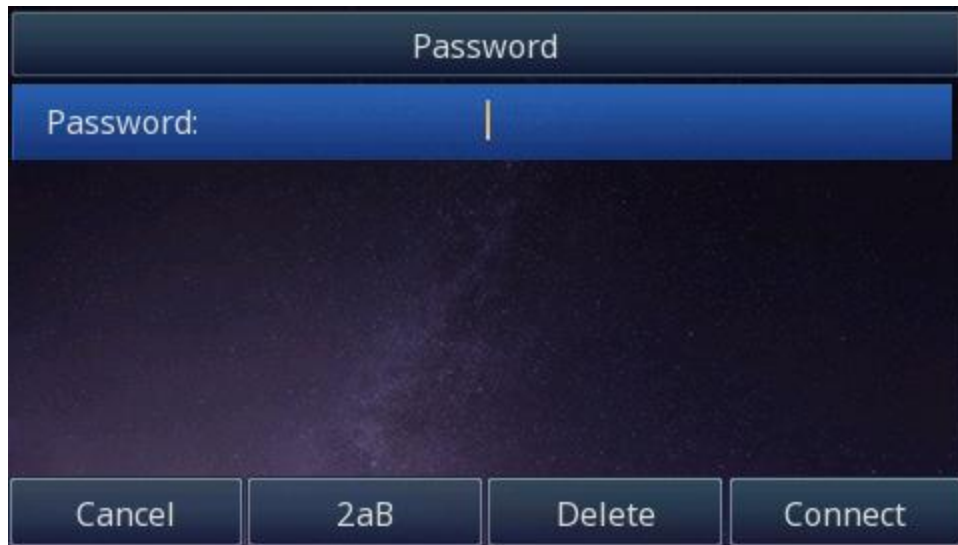

6. You must enter the wireless network's password:

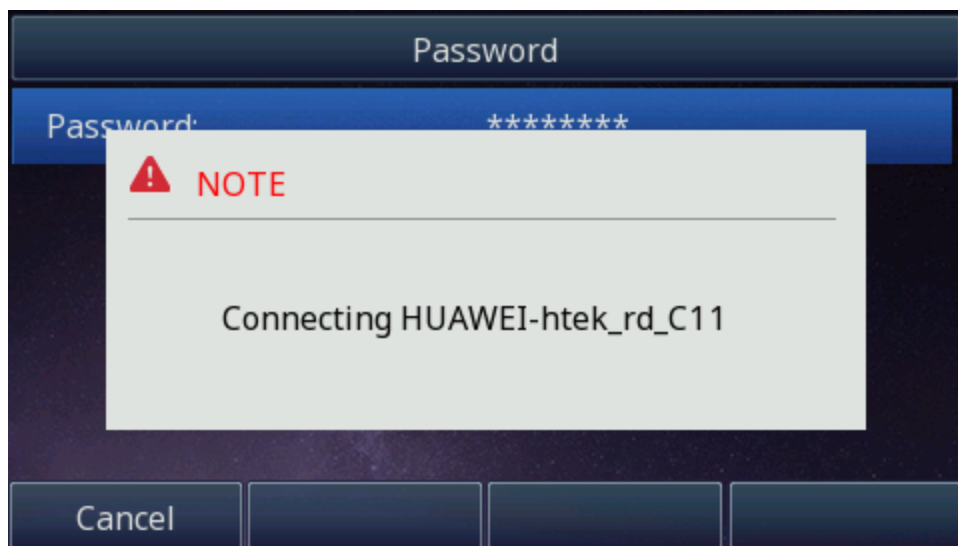

7. If the wireless network's password is correct, the wireless network will connect successfully:



How to view Wireless Network status?

1. You will see the wireless network connected successfully icon when phone connects wireless network successfully and back to idle interface:



2. You can see the wireless network' detail information as follow:
Menu->Status->Information:



Or as follow:

Menu->Settings->Basic Setting->Wi-Fi: wireless status:



How to Disconnect Wireless Network?

Disconnect wireless network via Phone interface:

1. Find Menu then navigate as follows
Menu->Settings->Basic Setting->Wi-Fi: The Storage Network:



2. Press the “Disconnect” button to disconnect this wireless network:

How to Manually add a Wireless Network?

Add a Wireless Network Manually via Phone interface:

1. Find Menu then navigate as follows
Menu->Settings->Basic Setting->Wi-Fi: The Storage Network:



2. Press the “Add” button to add a wireless network:

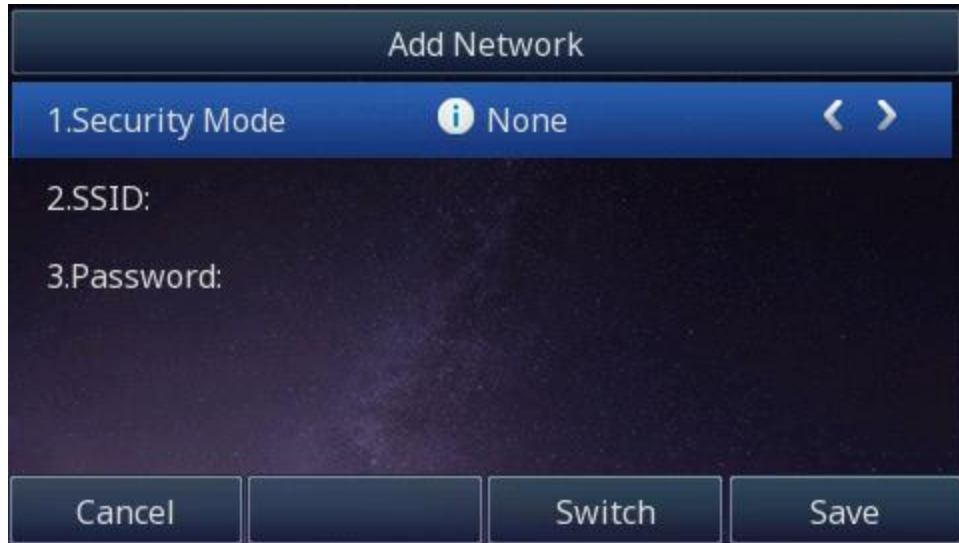

Select a Security Mode

Enter the desired wireless network (SSID)

If the wireless network is secure, please enter its password in the password field.

3. Press the "Save" button to save the configuraion:



You can choose this wireless network to connect it.

Note:

Contact your network administrator for the Wi-Fi password.

How to Disable Wi-Fi feature?

To disable the Wi-Fi feature via Phone interface:

1. Find Menu then navigate as follows
Menu->Settings->Basic Setting->Wi-Fi:
2. Press the Switch button to turn off Wi-Fi feature
3. Press the Save button to save the configuration.

Provision



Provision can be assigned to the phone in batches, which can be used in provisioning a large number of IP Phones to access the same Wi-Fi. Provision can be configured using the configuration file or phone. For more details, you can refer to

[Htek IP Phones Administrator Guide V4 4 24.](#)

To configure the Wi-Fi type via Phone interface:

1. Find Menu then navigate as follows
Menu->Settings->Basic Setting->Wi-Fi.
Press the Switch button to switch to the Provision Mode and enter.



2. Press  and  or press Switch button to turn on Wi-Fi feature
3. Select Security Mode->Enter the SSID value for Wi-Fi->Enter WPA Share Key value.



Note:

When you connect the Ethernet cable, you can enable the Wi-Fi feature. But you have to disable the Wi-Fi feature if you want to use the wired network. Wi-Fi that is designated by the server will override the user-defined Wi-Fi.

Upgrade

Factory Reset

To set Factory Reset via Phone interface

1. Press Menu → Settings → Advanced Setting (default password: **admin**) → Phone Setting → Factory Reset
1. Press OK soft key in the warning page.

To set Factory Reset via Web interface

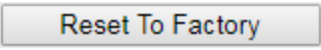
1. Click Management → Upgrade
2. Click  and then confirm the setting.

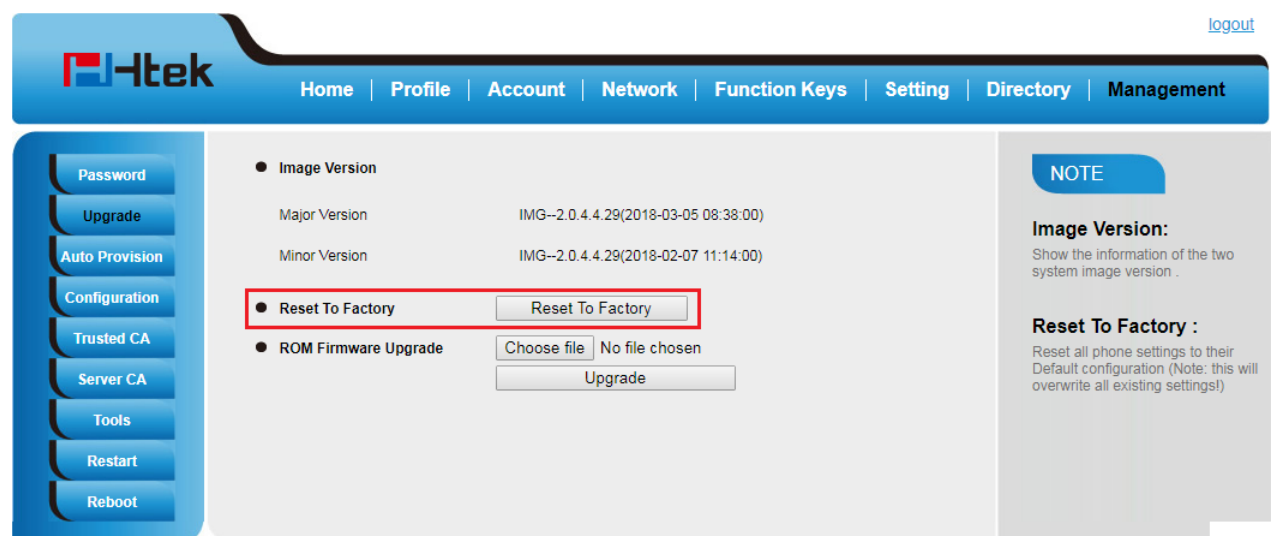

Pcap Feature

To use pcap via Web interface :

1. Click Management → Tools
2. Click Start and then operation the phone
3. When finish the operation, click Stop and then click Export.
4. Then you'll get the Pacp captures.

The screenshot shows the Htek web interface. On the left is a vertical navigation menu with buttons for Password, Upgrade, Auto Provision, Configuration, Trusted CA, Server CA, Tools, Restart, and Reboot. The main content area has a top navigation bar with links for Home, Profile, Account, Network, Function Keys, Setting, Directory, and Management. Below this, there are three configuration sections: 'Pcap Feature' (with Start, Stop, and Export buttons), 'Lcd Screen' (with a Save Screen button), and 'Port Mirror' (with Disable and Enable radio buttons). At the bottom of these sections are SaveSet and Restart buttons.

System Log

To download system log via Web interface :

1. Click Management→ Configuration

The screenshot shows the 'System Log' configuration page. It has a title 'System Log' and three main fields: 'Download System Log' with a 'Download' button, 'Syslog Server' with an empty text input field, and 'Syslog Level' with a dropdown menu currently showing 'NONE'. At the bottom of the page are 'SaveSet' and 'Cancel' buttons.

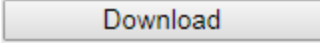
2. Click  of the system Log

3. Then you'll get a tgz file: syslog.tgz.

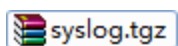

Upgrade

To upgrade via HTTP, the “Management”-> “auto provision” -> “Firmware Upgrade”-> “Upgrade Mode” field needs to be set to HTTP, respectively. “Firmware Server Path” needs to be set to a valid URL of a HTTP server, server name can be in either FQDN or IP address format. Here are examples of some valid URL.

e.g. firmware.mycompany.com:5688/Htek

e.g. www.mycompany.com:5688/fm/ Htek

e.g. 218.2.83.110

Instructions for firmware upgrade via HTTP:

(1) End users can choose to download the free HTTP server from <http://httpd.apache.org/> or use

Microsoft IIS web server. Then setup HTTP server.

(2) Unzip the firmware file and put all of them under the *root/fm* directory of the HTTP server.

(3) Visiting “<http://192.168.0.254/fm/fw926E.rom> on localhost by browser” to verify the HTTP Server. If visiting “<http://192.168.0.254/fm/fw926E.rom> on another computer and it not prompted to download fw926E.rom file on this computer, please check if the firewall is on or off (Suggest you turn off the firewall).

To configure the server path via Web interface :

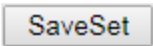
1. Click Management→ Auto provision:
2. Select the upgrade mode in the Upgrade Mode field
3. Enter the Firmware Server Path and Config Server Path (192.168.0.254 is HTTP server).
4. Enter the HTTP server’s username and password (optional).
5. Click the  button to save the configuration.
6. Restart the UC926E, IP Phone will restart and auto-get firmware files from HTTP server.

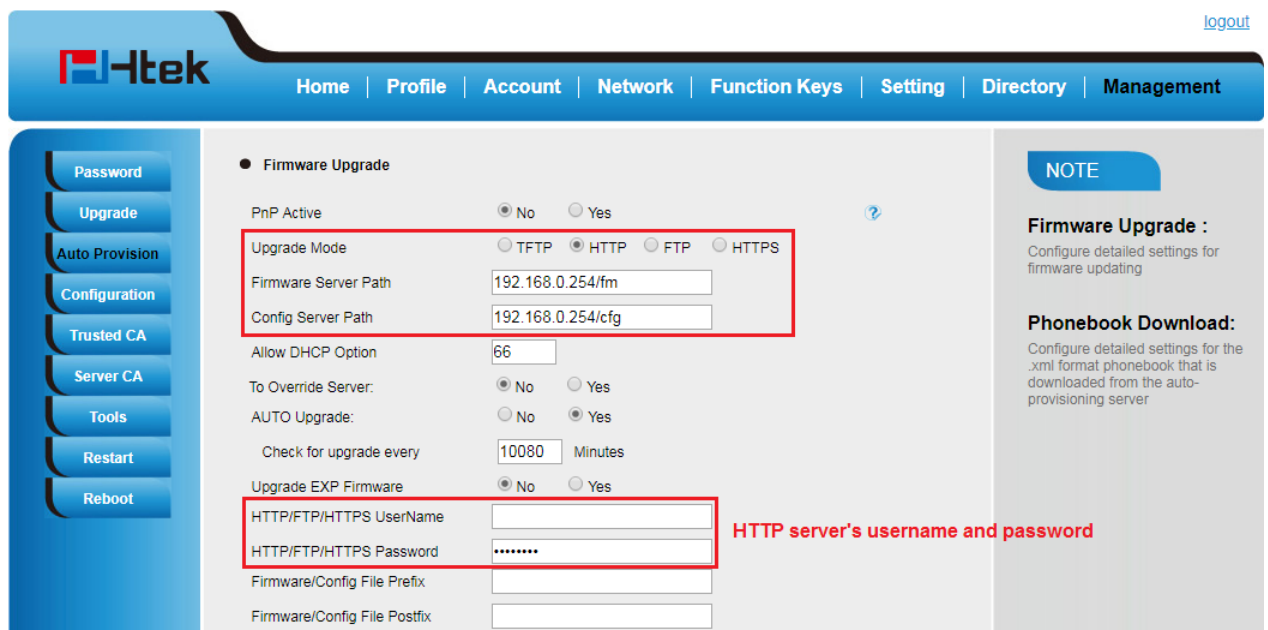

NOTES:

- Htek recommends end-user use the Htek HTTP server. For large companies, we recommend to maintain their own TFTP/HTTP/FTP/HTTPS server for upgrade and provisioning procedures.
- Once a “Firmware Server Path” is set, user needs to update the settings and restart the IP Phone. If the configured firmware server is found and a new code image is available, the UC926E will attempt to retrieve the new image files by downloading them into the UC926E’s SDRAM. During this stage, the UC926E’s LEDs will blink fastly until the checking/downloading process is completed. Upon verification of checksum, the new code image will then be saved into the Flash. If TFTP/HTTP/FTP/HTTPS fails for any reason (e.g. TFTP/HTTP/FTP/HTTPS server is not responding, there are no code image files available for upgrade, or checksum test fails, etc), the UC926E will stop the TFTP/HTTP/FTP/HTTPS process and simply boot using the existing code image in the flash.
- Firmware upgrade may take as long as 3 to 8 minutes over Internet, or just 1 minutes if it is performed on a LAN. It is recommended to conduct firmware upgrade in a controlled LAN environment if possible. For users who do not have a local firmware upgrade server.
- Htek’s latest firmware is available at www.htek.com → Support → Document & Firmware.
- Oversea users are strongly recommended to download the binary files and upgrade firmware locally in a controlled LAN environment.

To upgrade manually via the Web configuration interface

1. Click Management → Upgrade

2. Click or the blank.

3. Select the firmware (fw926E.rom) and then click .

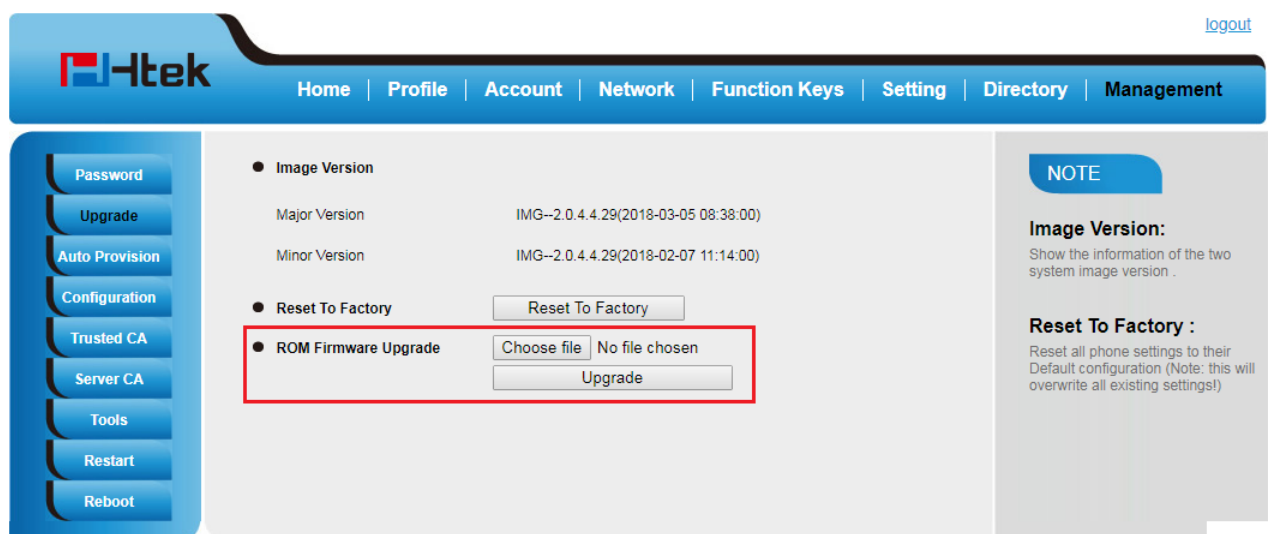

Configuration File

To download configuration file:

1. Click Management → Configuration → Configure File
2. Click the or , then you can get a file: cfg.bin or cfg.xml

● **Configure File**

Download Device Xml Configuration	<input type="button" value="Download Xml File"/>
Restore Xml Configuration	<input type="button" value="Choose file"/> No file chosen <input type="button" value="Restore Xml Configuration"/>
Download Device Bin Configuration	<input type="button" value="Download Bin File"/>
Restore Bin Configuration	<input type="button" value="Choose file"/> No file chosen <input type="button" value="Restore Bin Configuration"/>
Download User Bin Configuration	<input type="button" value="Download User Bin File"/>
Delete User Configuration	<input type="button" value="Delete User File"/>

To Restore a configuration file:

1. Click Management → Configuration → Configure File
2. Select the xxx.bin or xxx.xml file, and then Click the or , then IP Phone will reboot.

● **Configure File**

Download Device Xml Configuration	<input type="button" value="Download Xml File"/>
Restore Xml Configuration	<input type="button" value="Choose file"/> No file chosen <input type="button" value="Restore Xml Configuration"/>
Download Device Bin Configuration	<input type="button" value="Download Bin File"/>
Restore Bin Configuration	<input type="button" value="Choose file"/> No file chosen <input type="button" value="Restore Bin Configuration"/>
Download User Bin Configuration	<input type="button" value="Download User Bin File"/>
Delete User Configuration	<input type="button" value="Delete User File"/>

Troubleshooting

Why is the phone LCD screen blank?

- Ensure your phone is properly plugged into a functional AC outlet.
- If the phone is plugged into a power strip, try plugging it directly into a wall outlet instead.
- If your phone is powered from PoE, ensure you use a PoE compliant switch or hub, or contact your system administrator for more information.
- Check if the power LED is on to ensure that the phone is powered on.

When the phone display “Network Unavailable”?

To resolve:

- Ensure that the Ethernet cable is plugged into the right port on the phone and the Ethernet cable is not loose.
- Ensure that the switch or hub in your network is functioning well.
- If the problem still persists, Contact your system administrator for more information.

When you can't I get a dial tone?

To resolve:

- Check for any loose connections and that the phone has been installed properly. For the Installation instructions, refer to the phone installation section.
- Check whether dial tone is present on one of the audio modes.
- Switch between the Handset, Headset (if you have) or Hands-Free Speakerphone to check whether dial tone is present for one of the audio modes.
- If the dial tone exists on another audio mode, connect a different handset or headset to isolate the problem.

Where to set the tone?

You can set the tone on web interface:

- Click Setting→ Tones
- Define the dial tone, ringing, busy tone...
- For the tones, you can check with your system administrator.
- For More Click [Tone Notes](#).

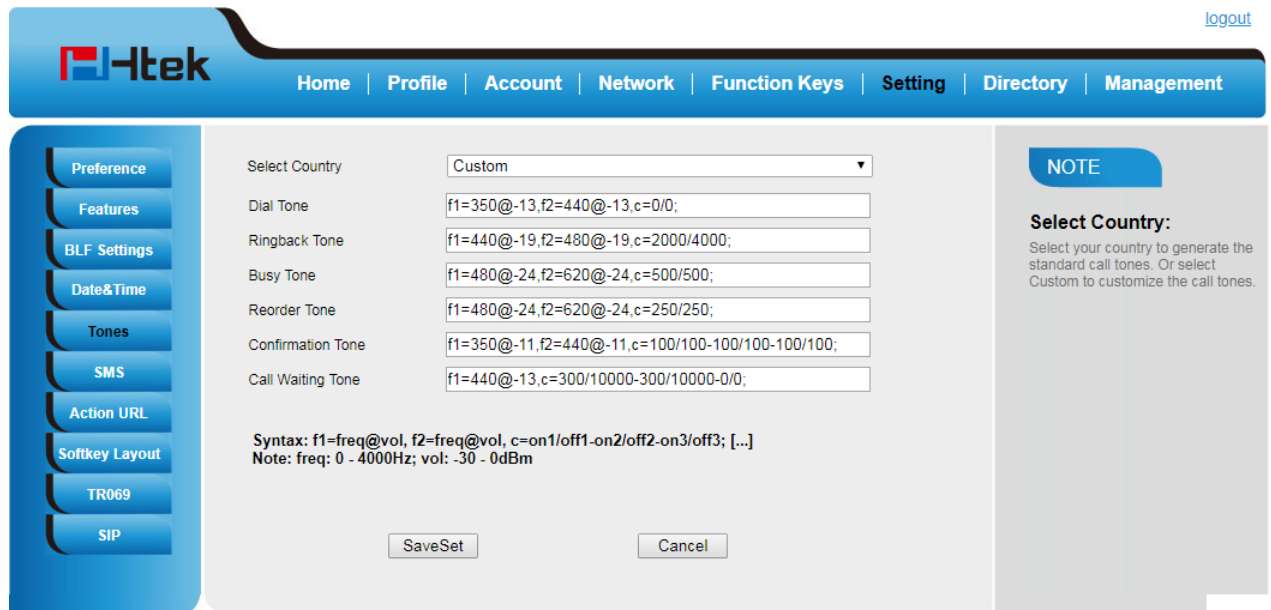

Select Country: Custom

Dial Tone: f1=350@-13,f2=440@-13,c=0/0;

Ringback Tone: f1=440@-19,f2=480@-19,c=2000/4000;

Busy Tone: f1=480@-24,f2=620@-24,c=500/500;

Reorder Tone: f1=480@-24,f2=620@-24,c=250/250;

Confirmation Tone: f1=350@-11,f2=440@-11,c=100/100-100/100-100/100;

Call Waiting Tone: f1=440@-13,c=300/10000-300/10000-0/0;

Syntax: f1=freq@vol, f2=freq@vol, c=on1/off1-on2/off2-on3/off3; [...]
 Note: freq: 0 - 4000Hz; vol: -30 - 0dBm

SaveSet Cancel

NOTE
Select Country:
 Select your country to generate the standard call tones. Or select Custom to customize the call tones.

Why can't the phone detect the Bluetooth headset?

- Ensure the Bluetooth headset is turned on.
- Ensure the Bluetooth headset is in pairing mode, when the phone is searching for Bluetooth headsets.

Why there is a noise in the Bluetooth headset?

- Check the battery level. If the battery level is low, charge the Bluetooth headset.
- Ensure the Bluetooth headset and the phone are within the working range of 10 meters (32 feet) and there is no obvious interference (walls, doors, etc.) between them.

Why the Bluetooth headset cannot be off-hook?

- Bluetooth headset industry rules is not possible to achieve off-hook, but the Bluetooth headset can be achieved to answer the phone, double-click the answer key to call back, hang up the phone and other operations

Why can't the IP phone connect to Wi-Fi?

- If the network is secure, ensure the entered password is right.
- Ensure your gateway/router enables the wireless network feature.
- Reboot your gateway/router.
- Turn off the Wi-Fi feature on the IP phone and then turn it on again.

Why is the wireless signal strength low?

- Ensure the IP phone and your gateway/router are within the working range and there is no obvious interference (walls, doors, etc) between them.

How to download XML Configuration?

- Click Management → Configuration →

How to Import Trusted CA certificate?

- Click Management → Trusted CA

The screenshot shows the Htek web interface. At the top, there is a navigation bar with the Htek logo and a 'logout' link. Below the navigation bar, there are several menu items: Home, Profile, Account, Network, Function Keys, Setting, Directory, and Management. On the left side, there is a vertical menu with items: Password, Upgrade, Auto Provision, Configuration, Trusted CA (highlighted), Server CA, Tools, Restart, and Reboot. The main content area is divided into two sections. The top section is a table with columns: Index, Issued TO, Issued By, Expiration, and Delete. The table contains 10 rows, each with a delete checkbox. Below the table is a 'Delete' button. The bottom section is a form for importing and configuring certificates. It includes a file upload area with a 'Choose file' button and a 'No file chosen' message. Below this is an 'Import Trusted Certificates' button. There are three radio button options: 'Only Accept Trusted Certificates' (On/Off), 'Common Name Validation' (On/Off), and 'Trusted Certificates' (Default Certificates, Custom Certificates, All Certificates). At the bottom of the form are 'SaveSet' and 'Cancel' buttons. On the right side of the page, there is a 'NOTE' box that says: 'Trusted CA: you can import TLS certificate file here.'

How to Import Server CA certificate?

- Click Management → Server CA

How to use Vlan?

- For Vlan information, please click [VLAN Note](#)

How to use LLDP?

- For LLDP information, please click [VLAN Note](#)
- VLAN Notes including:
 1. Voice VLAN
 2. Major Benefits of Using VLANs
 3. VLAN discovery method on Htek ip phones
 4. LLDP Feature on Htek IP Phones
 5. Supported TLVS of IP Phones
 6. Configuring LLDP Feature
 7. DHCP VLAN
 8. Open the DHCP VLAN on the Htek IP Phones
 9. VLAN under Bridge Mode
 10. VLAN under NAT Mode

How to Set LCD and Web GUI?

- Click [LCD and Web GUI custom Guide](#)

How to Upgrade via FTP?

- Click [How to Upgrade Note](#)

How to make Ringtone?

- Click [How to Make Ringtone](#)

How to use Open VPN?

- Click [Open VPN note](#)

Provisioning Guide on Free PBX

- Click [Set Auto Provision on FreePBX](#)

Redundancy Server

- Click [Redundancy Server](#)

How to Use Auto Provision Phonebook?

- Click [About AP Phonebook](#)

All Documents

- Click [Documents Guide](#), you can get all tech files.