

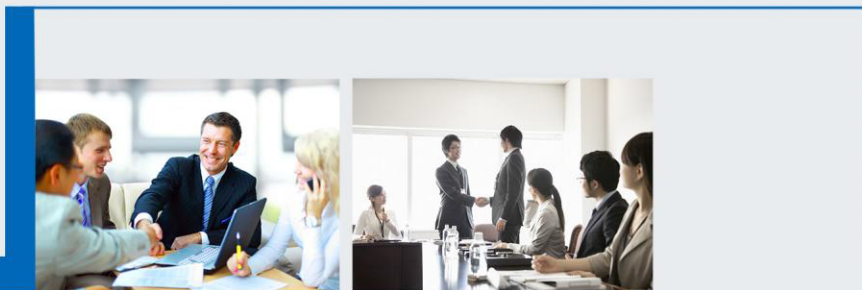

# Htek UC46 User Manual



**Version 2.0.4.4.24**  
**Feb. 2018**

# Notices Information

## Copyright

Copyright © 2005 - 2018 Nanjing Hanlong Technology CO., LTD. All rights reserved.

Nanjing Hanlong Technology Co., LTD. owns all the rights to modify and copy this document at any time. And all the illustrations and text in this document are copyright protected. Therefore, no parts of this document may be used or reproduced, transmitted by the third parties for any purposes without the express written permission of Nanjing Hanlong Technology CO., LTD.

When this document is made available on [www.htek.com](http://www.htek.com), Nanjing Hanlong Technology Co., LTD. gives its right to download and print copies of this content only for private use as a user manual. No parts shall have the right to alter, modify or use as commercial means without prior written permission from Nanjing Hanlong Technology Co., LTD.

## Safety Instructions

- To use the expansion module, please follow the instructions in this user manual.
- Use the power adapter supplied with your expansion module. Other power adapters may damage the expansion module.
- This expansion module is only for indoor use. And also avoid in high humidity, water and some other liquids.
- Do not use the expansion module during thunderstorms.
- CE
- FCC

## WEEE Warning



To avoid the potential effects on the environment and human health as a result of the presence of hazardous substances in electrical and electronic equipment, end users of electrical and electronic equipment should understand the meaning of the crossed-out wheeled bin symbol. Do not dispose of WEEE as unsorted municipal waste and have to collect such WEEE separately.

## Cleaning

To clean the device, use an anti-static cloth. Please avoid cleaning liquids as they might

damage the surface or internal electronics of the expansion module.

## FCC Statement

1. This device complies with Part 15 of the FCC Rules. Operation is subject to the following two conditions:

- (1) This device may not cause harmful interference.
- (2) This device must accept any interference received, including interference that may cause undesired operation.

2. Changes or modifications not expressly approved by the party responsible for compliance could void the user's authority to operate the equipment.

NOTE: This equipment has been tested and found to comply with the limits for a Class B digital device, pursuant to Part 15 of the FCC Rules. These limits are designed to provide reasonable protection against harmful interference in a residential installation.

This equipment generates uses and can radiate radio frequency energy and, if not installed and used in accordance with the instructions, may cause harmful interference to radio communications. However, there is no guarantee that interference will not occur in a particular installation. If this equipment does cause harmful interference to radio or television reception, which can be determined by turning the equipment off and on, the user is encouraged to try to correct the interference by one or more of the following measures:

- Reorient or relocate the receiving antenna.

- Increase the separation between the equipment and receiver.

- Connect the equipment into an outlet on a circuit different from that to which the receiver is connected.

- Consult the dealer or an experienced radio/TV technician for help.

# Table of Content

Notices Information .....	1
Copyright.....	2
Safety Instructions.....	2
WEEE Warning .....	2
Cleaning.....	2
FCC Statement.....	3
Table of Content.....	4
Getting Started .....	6
Packing List.....	6
Expansion Module Installation .....	8
1. Connect the expansion module and IP Phone .....	8
2. Attach the Foot stand.....	9
3. Connect the IP Phone and Power.....	9
Getting Familiar with Expansion Module .....	10
Hardware Components Preview .....	10
Icon Preview.....	11
Features Configuration .....	13
Screen Saver .....	13
Line.....	13
Speed Dial.....	14
BLF .....	15
BLF List.....	16
Voice Message.....	17
Direct Pickup.....	18
Group Pickup .....	18
Call Park .....	19
Intercom.....	20
DTMF.....	21
Prefix.....	22
Local Group.....	23
XML Group.....	24
LDAP .....	24
Broadsoft Group.....	25
Conference.....	25
Forward.....	26
Transfer.....	27
Hold .....	27
Group Listening.....	28
DND .....	29
Redial.....	29
Call Return.....	30

---

SMS .....	30
Record .....	31
URL Record .....	32
Paging.....	32
Public Hold .....	33
Private Hold.....	33
Hot Desking.....	34
ACD .....	35
Zero Touch.....	35
URL.....	36
MultiCast Paging .....	36
Upgrade .....	37
IP Phone upgrades the expansion module FW .....	37
Expansion module gets the fw46.rom from IP Phone .....	38

# Getting Started

## Packing List

The package contains the following parts, please check if all the items are not missed:

1. The Expansion module device

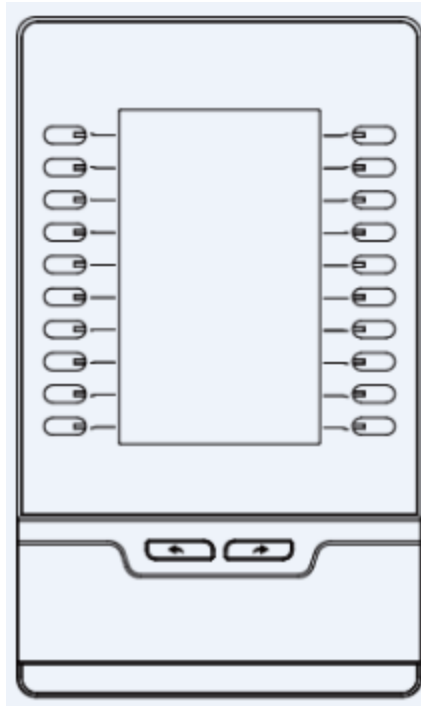

2. The Stand

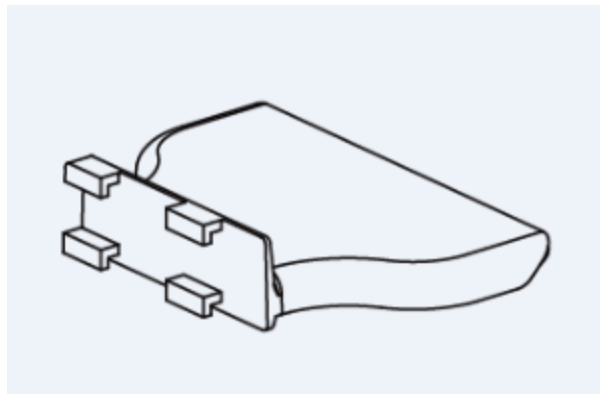

3. Connecting Sheet

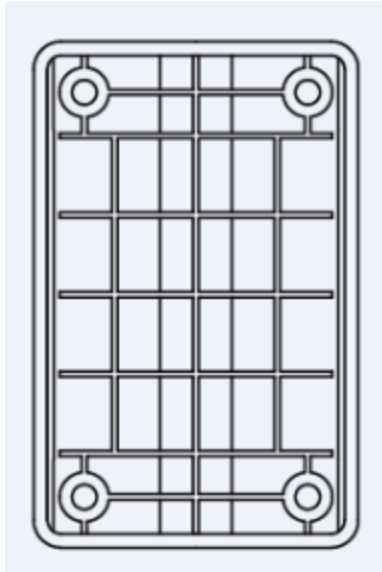

4. Power adapter

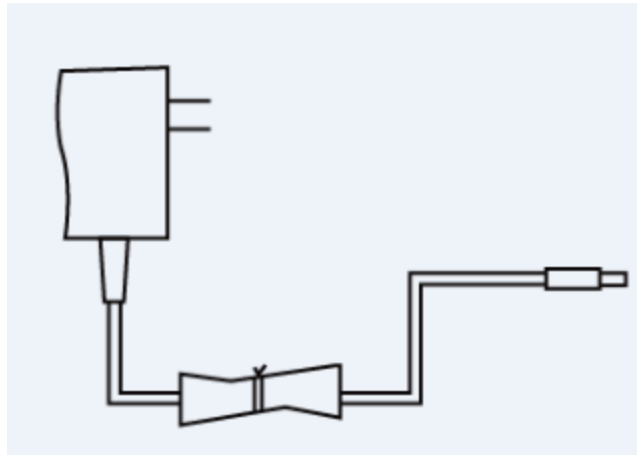

5. Ethernet cable/Connecting Cord

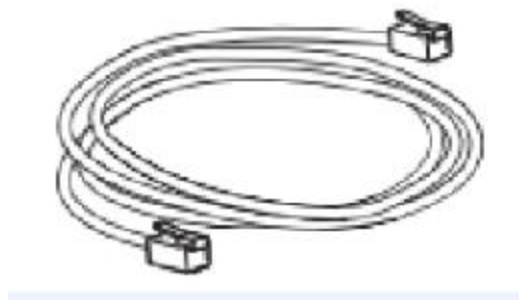

6. Quick installation reference



7. Quick installation reference



## Expansion Module Installation

### 1. Connect the expansion module and IP Phone

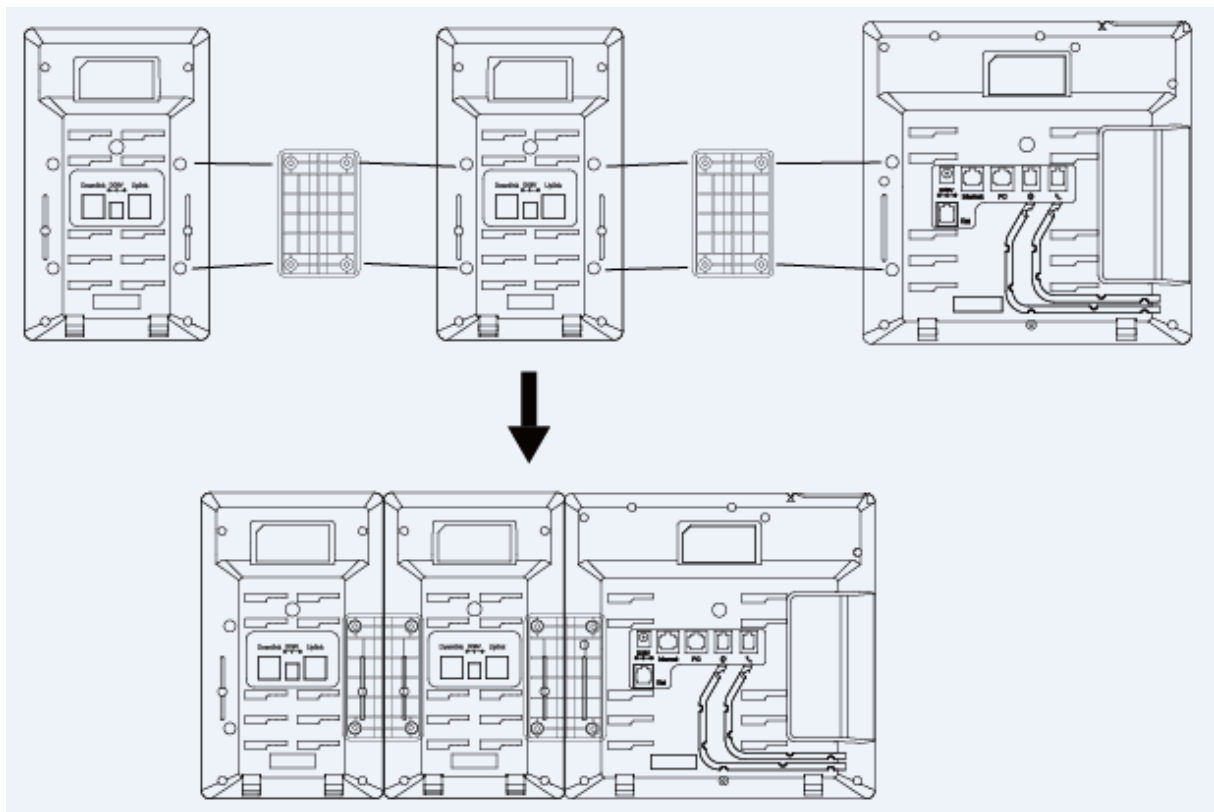



## 2. Attach the Foot stand

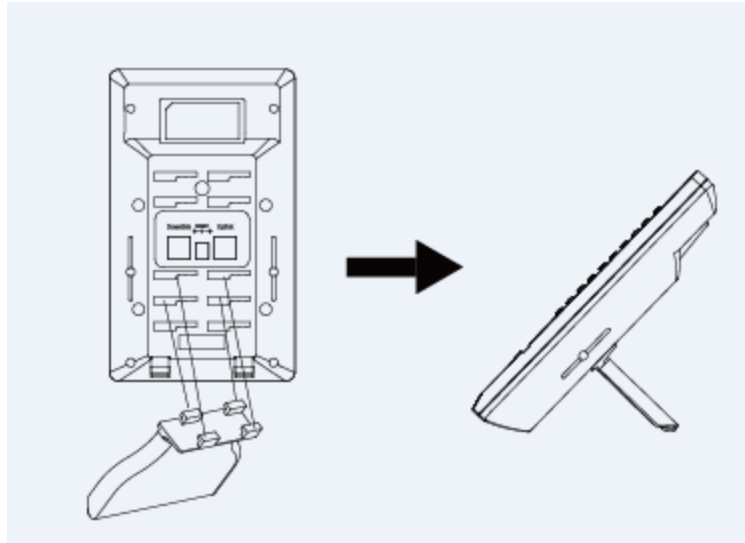

## 3. Connect the IP Phone and Power

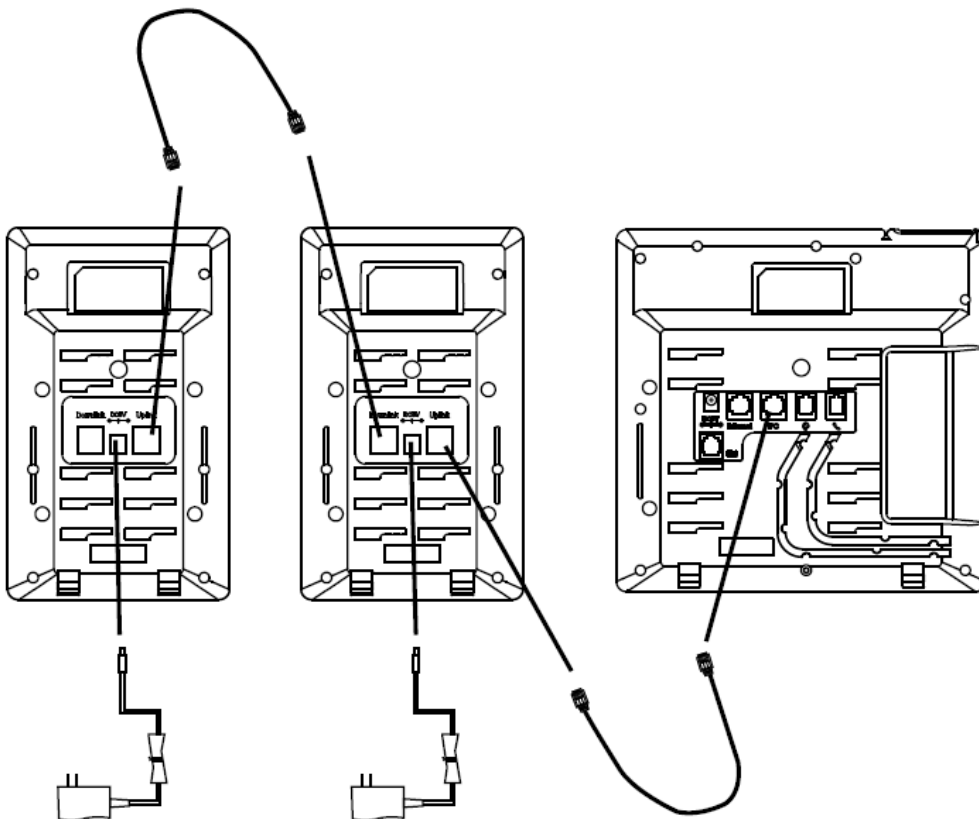

**Note :**







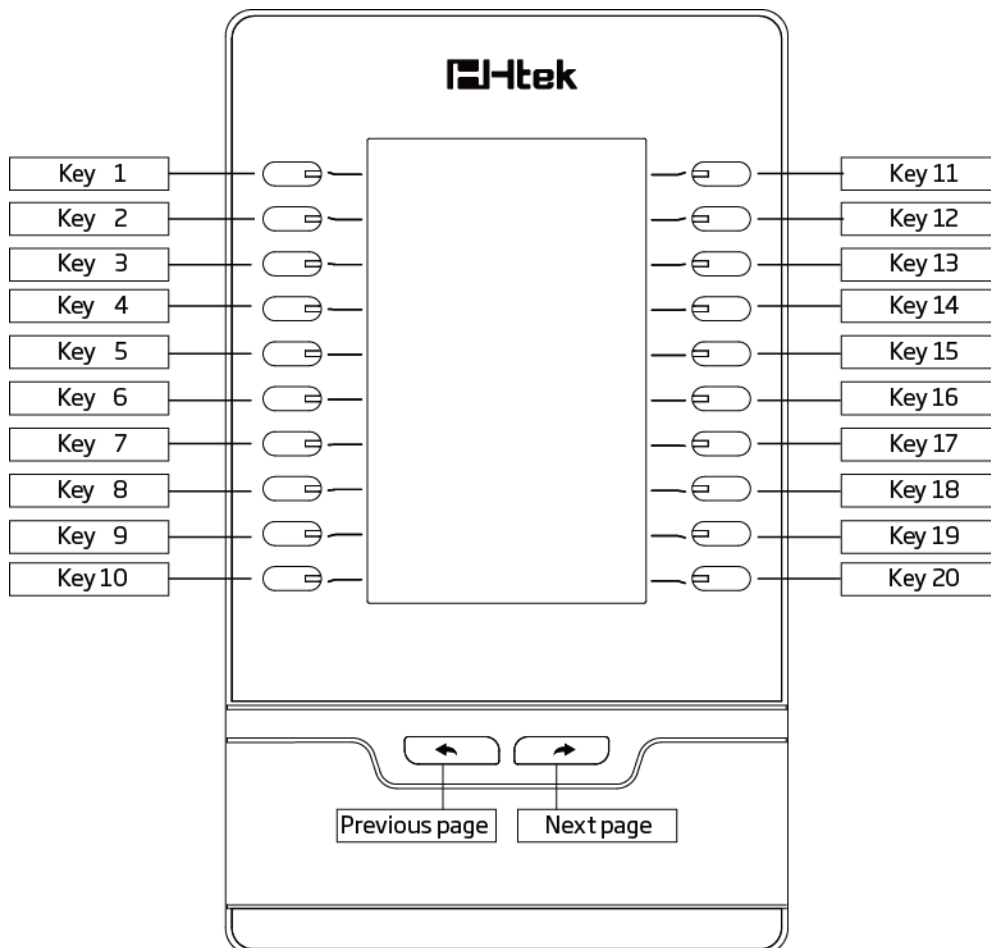







1. In order to use the UC46, you must first change a setting in the phone attached to the UC46 to accept Expansion Modules on the PC Port. This setting can be found in the phone menu under "Settings / Advanced Settings / Network / PC Port" or in the web GUI under "Network / PC Port".
2. Our expansion modules must be connected to the IP Phone's PC port and can't be connected to the any switches in a LAN.
3. Our IP phone UC860 can support six expansion modules at most.















## Getting Familiar with Expansion Module

### Hardware Components Preview



## Icon Preview

Icon	Description
	Line(Registered succeed)
	Line (Unregistered)
	Line(Ringing)
	Speed Dial
	BLF
	BLF(Ringing)
	BLF(Talking)
	Voice messages
	Pick up
	Call Park
	Intercom/Paging
	DTMF
	Prefix
	XML Group
	Local Group

	XML Browser
	LDAP
	Broadsoft Group
	Conference
	Forward
	Transfer
	Hold
	Line on Hold
	DND
	Redial
	Call Return
	SMS
	Record
	Recording
	Group Listening
	Shared Line
	Other Functions

# Features Configuration

## Screen Saver

It supports a screen saver.

### To configure screen saver via Web Interface:

1. Click Setting → Preference.
2. Filled the time for Expansion screensaver time
3. Click the  to save the configuration.

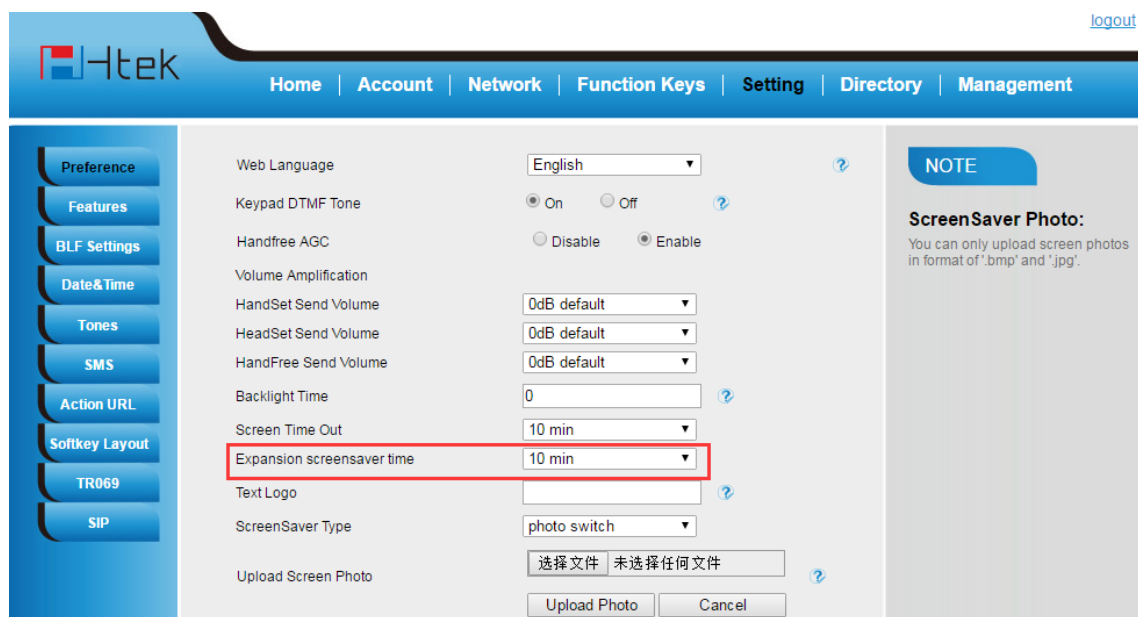

The screenshot shows the Htek web interface for configuring preferences. The 'Preference' menu is selected on the left. The 'Expansion screensaver time' dropdown is highlighted with a red box and set to '10 min'. A 'SaveSet' button is visible in the top right of the configuration area. A 'NOTE' box on the right states: 'ScreenSaver Photo: You can only upload screen photos in format of '.bmp' and '.jpg'.

## Line

It works same as Line keys.

Line support three Mode (Default, lock and float)

**Default mode:** If the phone has a incoming call, it means that the phone will not jump to the first page when the first page set the line type and current page is four page.

**Lock mode:** it means that the other page's same position has the same line when the first

page set the line type.

**Float mode:** If the phone has a incoming call, it means that the phone will jump to the first page when the first page set the line type and current page is four page.

**To configure Line Feature via Web Interface**

4. Click Function keys →EXP Key.
5. Select the wanted Key and set as Line.
6. Select the Account.
7. Click the  to save the configuration.

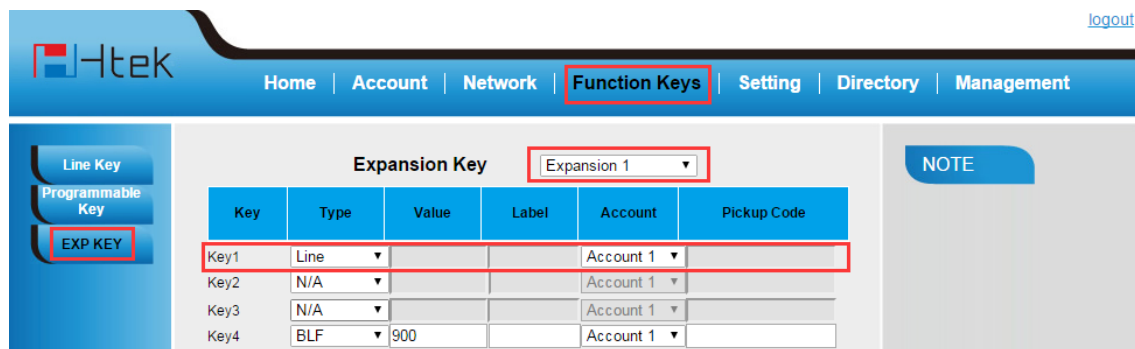

## Speed Dial

With this feature, you can dial one directory by press the definite key.

**To configure Speed Dial feature via Web Interface**

1. Click Function keys →EXP Key.
2. Select the wanted Key and set as Speed Dial.
3. Enter the desired phone number in the Value field.
4. Filled the Label displayed on LCD
5. Select the Account.

- Click the  to save the configuration.

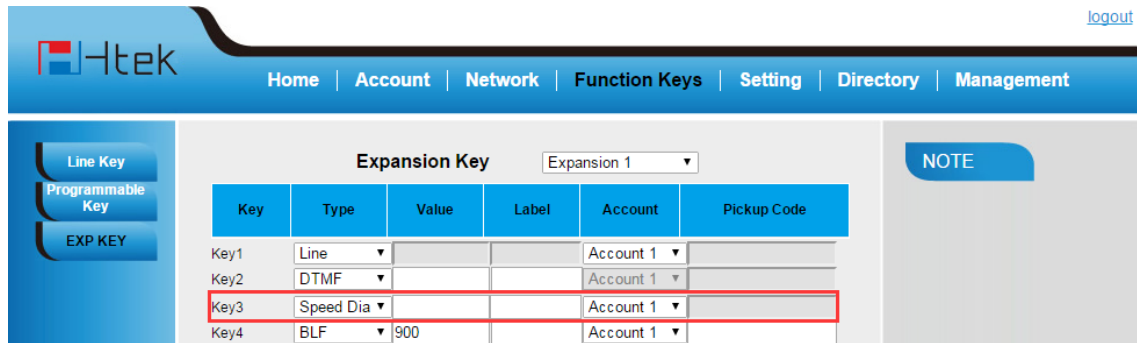

Expansion Key Expansion 1

Key	Type	Value	Label	Account	Pickup Code
Key1	Line			Account 1	
Key2	DTMF			Account 1	
Key3	Speed Dia			Account 1	
Key4	BLF	900		Account 1	

## BLF

You can use the BLF (Busy Lamp Field) feature to monitor a specific one whether his phone is busy or free.

- When the monitored line is idle, the light is steady green.
- When the monitored line is ringing, the light is blinking red, press the BLF key to pick the phone up directly.
- When the monitored line is calling or in a conversation, the light is steady red.

### To configure a BLF key by web

- Click Function keys → EXP Key.
- Select the desired Key and select BLF in the Type.
- Enter the monitored phone number in the Value field.
- Filled the Label displayed on LCD.
- Select the Account.
- Filled the Pickup code.
- Click the  to save the configuration.

[logout](#)

Htek

[Home](#) | [Account](#) | [Network](#) | [Function Keys](#) | [Setting](#) | [Directory](#) | [Management](#)

[Line Key](#)  
[Programmable Key](#)  
[EXP KEY](#)

**Expansion Key**
Expansion 1 ▾

Key	Type	Value	Label	Account	Pickup Code
Key1	Line ▾			Account 1 ▾	
Key2	Call Park ▾	691		Account 1 ▾	
Key3	Speed Dia ▾			Account 1 ▾	
Key4	BLF ▾	900		Account 1 ▾	

NOTE

**Note :**

**This feature is not available on all servers. For more information, contact your system administrator.**

**After setting the BLF key, do not need to restart the phone.**

## BLF List

**To configure BLF List via web interface:**

1. Login and click Account

* Account Active	<input type="radio"/> No <input checked="" type="radio"/> Yes	
* Primary SIP Server	<input type="text" value="as.iop2.broadworks.net"/>	?
Failover SIP Server	<input type="text"/>	?
Second Failover SipServer	<input type="text"/>	?
Prefer Primary SIP Server	<input checked="" type="radio"/> No <input type="radio"/> Yes	?
Outbound Proxy	<input type="text"/>	?
* SIP Transport	<input checked="" type="radio"/> UDP <input type="radio"/> TCP <input type="radio"/> TLS	?
NAT Traversal	<input type="radio"/> No <input checked="" type="radio"/> No,but send keep alive <input type="radio"/> STUN	
Lable	<input type="text"/>	?
* SIP User ID	<input type="text" value="2404984031"/>	?
* Authenticate ID	<input type="text" value="2404984031"/>	?
* Authenticate Password	<input type="password" value="*****"/>	?
Name	<input type="text" value="4031"/>	?
DNS Mode	<input checked="" type="radio"/> A Record <input type="radio"/> SRV <input type="radio"/> NAPTR/SRV	



2. Click Advanced and then fill the Eventlist BLF URL.

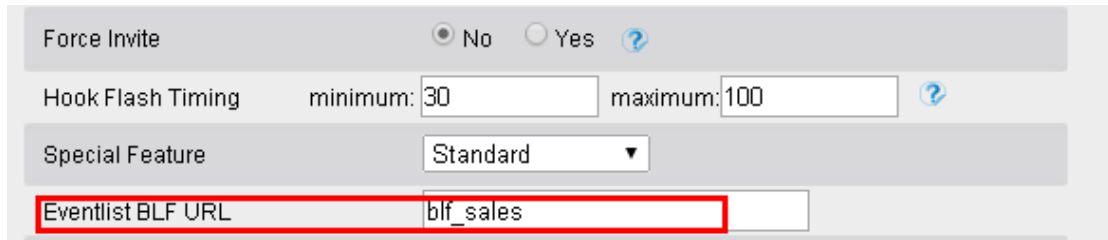

Force Invite  No  Yes ?

Hook Flash Timing minimum:  maximum:  ?

Special Feature

Eventlist BLF URL

3. To configure BLF List Keys

3.1 Click Function keys → EXP Key.

3.2 Select the BLF List in the Type Field.

3.3. Select Account

3.4 Click to  the configuration.

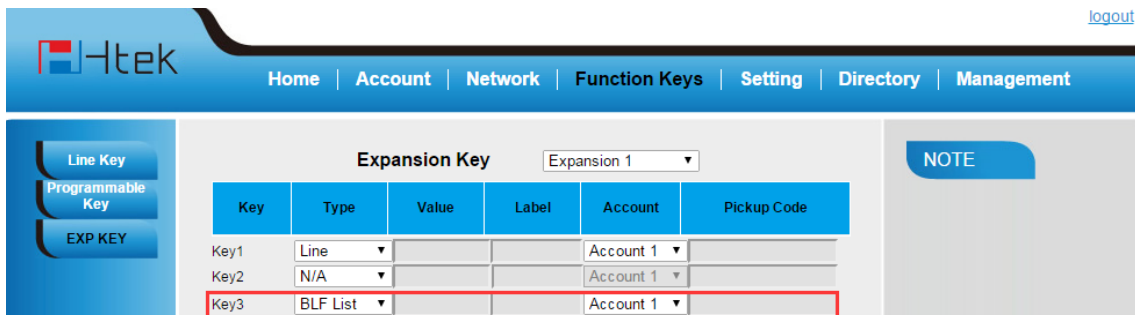

[logout](#)

**Htek** Home | Account | Network | **Function Keys** | Setting | Directory | Management

Line Key  
Programmable Key  
EXP KEY

**Expansion Key**

Key	Type	Value	Label	Account	Pickup Code
Key1	Line			Account 1	
Key2	N/A			Account 1	
Key3	BLF List			Account 1	

NOTE

## Voice Message

**To configure Voice Mail feature via Web Interface**

1. Click Function keys → EXP Key.
2. Select the wanted Key.
3. Enter the desired voicemail feature codes in the Value field.
4. Filled the Label displayed on LCD.
5. Select the Account.

6. Click the  to save the configuration.

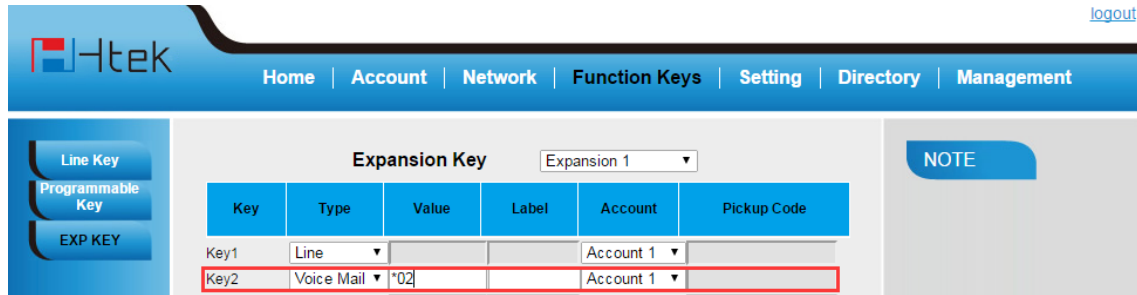

## Direct Pickup

With this feature, you can pick up the set line when it ringing.

### To configure Direct Pickup feature via Web Interface

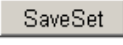
1. Click Function keys → EXP Key..
2. Select the wanted Key and set as Direct Pickup.
3. Enter the pickup code and followed the desired phone number in the Value field.
4. Filled the Label displayed on LCD.
5. Select the Account.
6. Click the  to save the configuration.

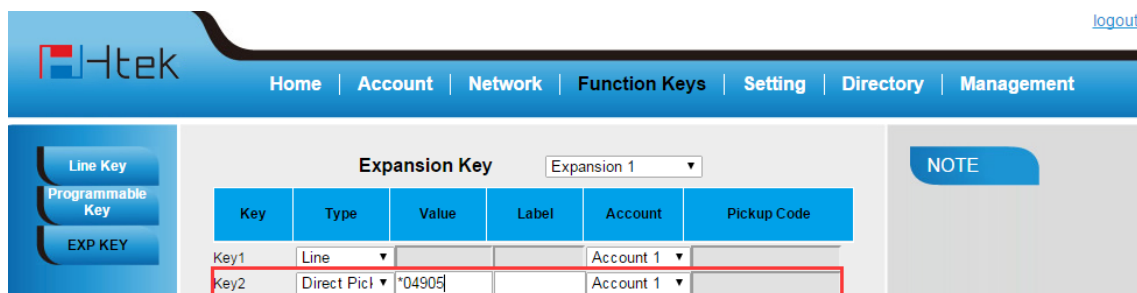

## Group Pickup

With this feature, you can pick up the specified group that you want incoming calls.

### To configure the Group Pick up via Web interface

1. Click Function keys → EXP Key.
2. Select the desired Key and select Group Pickup in the Type.
3. Enter the pickup code and followed the desired Group number in the Value field.
4. Filled the Label displayed on LCD..

5. Click the  to save the configuration.

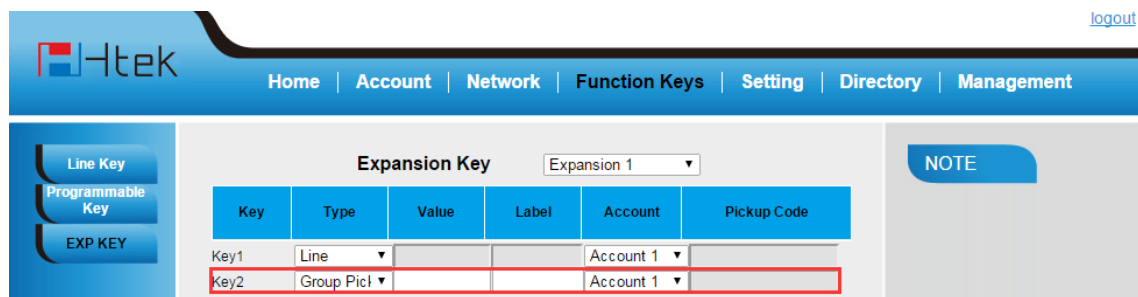

Key	Type	Value	Label	Account	Pickup Code
Key1	Line			Account 1	
Key2	Group Picl			Account 1	

## Call Park

With this feature, you can put a call on hold and continue the conversation from another phone.

### To configure the Call Park via Web interface

1. Click Function key → EXP Key.
2. Select the desired Key and select Call Park in the Type.
3. Enter the park feature codes in the value field.
4. Filled the Label displayed on LCD.
5. Select the Account.
6. Click the  to save the configuration.

Key	Type	Value	Label	Account	Pickup Code
Key1	Line			Account 1	
Key2	Group Pict			Account 1	
Key3	Call Park	70	70	Account 1	
Key4	Speed Dia			Account 1	

**Note:**

Your VoIP PBX must support this feature and enable this feature.

## Intercom

When use the intercom feature, you can quickly get access connect to the configured EXPension.

### To configure Intercom feature via Web Interface

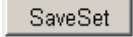
1. Click Function keys → EXP Key.
2. Select the wanted Key and select Intercom as the Type.
3. Enter the intercom codes followed by desired number in the Value field.
4. Filled the Label displayed on LCD.
5. Select the Account.
6. Click the  to save the configuration.

[logout](#)

Htek

[Home](#) | [Account](#) | [Network](#) | [Function Keys](#) | [Setting](#) | [Directory](#) | [Management](#)

Line Key

Programmable Key

EXP KEY

**Expansion Key** Expansion 1 ▾

Key	Type	Value	Label	Account	Pickup Code
Key1	Line ▾			Account 1 ▾	
Key2	Group Pict ▾			Account 1 ▾	
Key3	Call Park ▾	70	70	Account 1 ▾	
Key4	Intercom ▾	*5902		Account 1 ▾	
Key5	N/A ▾			Account 1 ▾	

NOTE

If you want to achieve the intercom feature, you must enable the “Allow Auto Answer By Call-Info”

1. Click the account
2. Select the desired account from the pull-down list of Account in the Account field.
3. Click the advanced
4. Enable the “Allow Auto Answer By Call-Info”
5. Click the button to save the configuration.

Send Anonymous	<input checked="" type="radio"/> No <input type="radio"/> Yes <a href="#">?</a>
Anonymous Call Rejection	<input checked="" type="radio"/> No <input type="radio"/> Yes
Check SIP User ID	<input checked="" type="radio"/> No <input type="radio"/> Yes
Auto Answer	<input checked="" type="radio"/> No <input type="radio"/> Yes
Allow Auto Answer By Call-Info	<input type="radio"/> No <input checked="" type="radio"/> Yes

**Note :**

**This feature is not available on all servers. For more information, contact your system administrator.**

## DTMF

When the key is configured as DTMF key, You are allowed to send out the desired DTMF number during the conversation.

To use this feature, you should sure that the DTMF Tone is on.

### To configure the DTMF via Web interface

1. Click Setting→Preference

2. Select On for Keypad DTMF Tone.
3. Click to  the configuration.

Keypad DTMF Tone

 On
  Off
 
?

### To configure the DTMF via Web interface

1. Click Function keys → EXP Key.
2. Select the desired Key and select DTMF in the Type.
3. Fill the value with the Desired DTMF number
4. Enter the Label displayed on LCD.
5. Click the  to save the configuration.

logout

Home
Account
Network
Function Keys
Setting
Directory
Management

Line Key  
 Programmable Key  
 EXP KEY

**Expansion Key**
Expansion 1 ▾

Key	Type	Value	Label	Account	Pickup Code
Key1	Line ▾			Account 1 ▾	
Key2	DTMF ▾	*6		Account 1 ▾	
Key3	N/A ▾			Account 1 ▾	

NOTE

## Prefix

If the key is configured as Prefix key, you can set the number prefix (e.g. Before the number plus 9), then you don't input 9, press the key and 9 will display on the LCD interface.

### To configure the Prefix via Web interface

1. Click Function key → EXP Key.
2. Select the desired Key and select Prefix in the Type.
3. Fill the value with number that you want to set as prefix

4. Enter Label displayed on LCD.
5. Click the  to save the configuration.

Then when you press this key, the set value is input directly.

Key	Type	Value	Label	Account	Pickup Code
Key1	Line			Account 1	
Key2	DTMF			Account 1	
Key3	Prefix	90		Account 1	

## Local Group

When use the Local Group feature, press the key and enter the local Contacts interface quickly.

### To configure the Local Group via Web interface

1. Click Function key → EXP Key.
2. Select the desired Key and select Local group in the Type.
3. Filled the Label displayed on LCD.
4. Click the  to save the configuration.

Then you can press the local group key to access the pre-defined contact group in the local directory quickly.

Line Key  
Programmable Key  
EXP KEY

Expansion Key Expansion 1

Key	Type	Value	Label	Account	Pickup Code
Key1	Line			Account 1	
Key2	DTMF			Account 1	
Key3	Local Grou			Account 1	
Key4	BLF	900		Account 1	

NOTE

## XML Group

When use the XML Group feature,press the key and enter the Remote Contacts interface quickly.

### To configure the Local Group via Web interface

1. Click Function key → EXP Key.
2. Select the desired Key and select XML group in the Type.
3. Filled the Label displayed on LCD.
4. Click the  to save the configuration.

Line Key  
Programmable Key  
EXP KEY

Expansion Key Expansion 1

Key	Type	Value	Label	Account	Pickup Code
Key1	Line			Account 1	
Key2	DTMF			Account 1	
Key3	XML Group			Account 1	
Key4	BLF	900		Account 1	

NOTE

## LDAP

When use the LDAP feature, you can get the LDAP Phonebook directly.

### To configure the LDAP via Web interface



1. Click Function key → EXP Key.
2. Select the desired Key and select LDAP in the Type.
3. Filled the Label displayed on LCD.
4. Click the  to save the configuration.

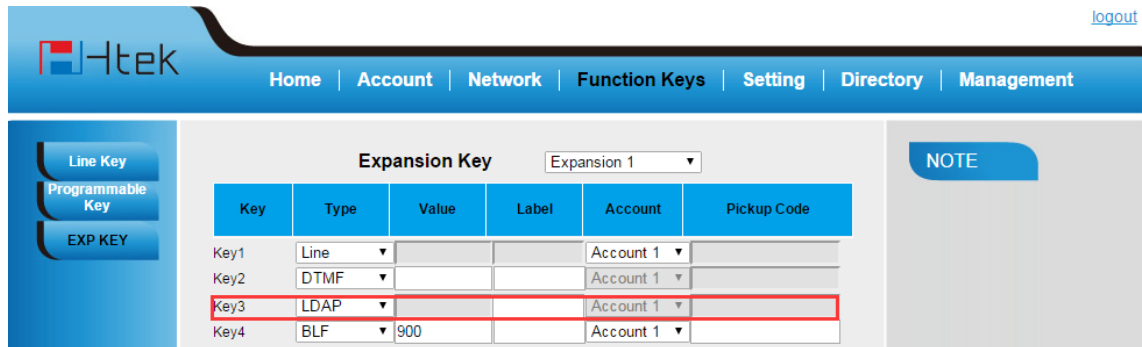

Key	Type	Value	Label	Account	Pickup Code
Key1	Line			Account 1	
Key2	DTMF			Account 1	
Key3	LDAP			Account 1	
Key4	BLF	900		Account 1	

## Broadsoft Group

When use the BroadSoft Group feature,press the key and enter the Remote Contacts interface quickly.

### To configure the Broadsoft group via Web interface

1. Click Function key → EXP Key.
2. Select the desired Key and select Broadsoft group in the Type.
3. Filled the Label displayed on LCD.
4. Click the  to save the configuration.

## Conference

The HanLong IP Phone supports up to 5-way conference. You are allowed to configure the programmable key to be used as a conference key.

### To configure Conference via Web Interface

1. Click Function keys →EXP Key.
2. Select the desired Key and select Conference in the Type.
3. Enter the Label displayed on LCD.
4. Click the  to save the configuration.

Expansion Key

Key	Type	Value	Label	Account	Pickup Code
Key1	Line			Account 1	
Key2	DTMF			Account 1	
Key3	Conferenc.			Account 1	
Key4	BLF	900		Account 1	

## Forward

If the key is configured as Forward key, press this key under the idle status, the IP phone will turn to the Always Forward interface and you can set the Forward to number, then when there is any call to the EXPension number will be forwarded to the set number automatically.

### To configure Forward via Web Interface

1. Click Function keys →EXP Key.
2. Select the desired Key and select Forward in the Type.
3. Enter the Value with the number you want to forward
4. Enter the Label displayed on LCD.
5. Click the  to save the configuration.

[logout](#)

Htek Home | Account | Network | **Function Keys** | Setting | Directory | Management

Line Key  
Programmable Key  
EXP KEY

**Expansion Key** Expansion 1

Key	Type	Value	Label	Account	Pickup Code
Key1	Line			Account 1	
Key2	DTMF	*6		Account 1	
Key3	Forward	906		Account 1	
Key4	N/A			Account 1	

NOTE

## Transfer

You are able to configure the key as a transfer key to perform the Blind/Attended Transfer.

### To configure Transfer via Web Interface

1. Click Function keys →EXP Key.
2. Select the desired Key and select Transfer in the Type.
3. Enter the Value with the number that wanted transfer to
4. Enter the Label displayed on LCD.
5. Click the  to save the configuration.

[logout](#)

Htek Home | Account | Network | **Function Keys** | Setting | Directory | Management

Line Key  
Programmable Key  
EXP KEY

**Expansion Key** Expansion 1

Key	Type	Value	Label	Account	Pickup Code
Key1	Line			Account 1	
Key2	DTMF	*6		Account 1	
Key3	Transfer	906		Account 1	
Key4	N/A			Account 1	

NOTE

## Hold

The key can be configured as a hold key. You can use this key to hold and resume a call during the conversation.

### To configure Hold via Web Interface

1. Click Function keys →EXP Key.
2. Select the desired Key and select Hold in the Type.
3. Enter the Label displayed on LCD.
4. Click the  to save the configuration.

The screenshot shows the Htek web interface with the 'Function Keys' menu selected. The 'Expansion Key' configuration page is displayed for 'Expansion 1'. A table lists four keys, with Key3 highlighted in red. Key3 is configured with Type 'Hold', Value (empty), Label (empty), Account 'Account 1', and Pickup Code (empty).

Key	Type	Value	Label	Account	Pickup Code
Key1	Line			Account 1	
Key2	DTMF			Account 1	
Key3	Hold			Account 1	
Key4	BLF	900		Account 1	

## Group Listening

### To configure Group listening via Web Interface

1. Click Function keys →EXP Key.
2. Select the desired Key and select Group listening in the Type.
3. Enter the Label displayed on LCD.
4. Click the  to save the configuration.

The screenshot shows the Htek web interface with the 'Function Keys' menu selected. The 'Expansion Key' configuration page is displayed for 'Expansion 1'. A table lists four keys, with Key3 highlighted in red. Key3 is configured with Type 'Group List', Value (empty), Label (empty), Account 'Account 1', and Pickup Code (empty).

Key	Type	Value	Label	Account	Pickup Code
Key1	Line			Account 1	
Key2	DTMF			Account 1	
Key3	Group List			Account 1	
Key4	BLF	900		Account 1	

## DND

If the key is configured as DND key, you are allowed to activate the DND function immediately when you press it and the phone is to reject all incoming calls automatically. Press it again to deactivate DND mode.

### To configure DND via Web Interface

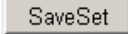
1. Click Function keys →EXP Key.
2. Select the desired Key and select DND in the Type.
3. Enter the Label displayed on LCD.
4. Click the  to save the configuration.

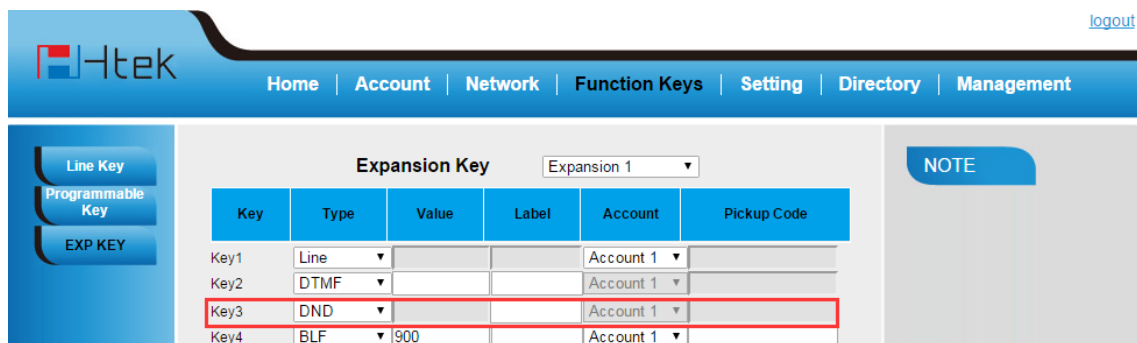

Key	Type	Value	Label	Account	Pickup Code
Key1	Line			Account 1	
Key2	DTMF			Account 1	
Key3	DND			Account 1	
Key4	BLF	900		Account 1	

## Redial

If the key is configured as Redial key, you can redial the last placed call from the IP Phone.

### To configure Redial via Web Interface

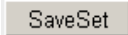
1. Click Function keys →EXP Key.
2. Select the desired Key and select redial in the Type.
3. Enter the Label displayed on LCD.
4. Click the  to save the configuration.

Line Key  
Programmable Key  
EXP KEY

Expansion Key Expansion 1

Key	Type	Value	Label	Account	Pickup Code
Key1	Line			Account 1	
Key2	DTMF			Account 1	
Key3	Redial			Account 1	
Key4	BLF	900		Account 1	

NOTE

## Call Return

When the key is configured as Call Return key you are allowed to dial out the last phone call you received.

### To configure Call Return via Web Interface

1. Click Function keys →EXP Key.
2. Select the desired Key and select Call Return in the Type.
3. Enter the Label displayed on LCD.
4. Click the  to save the configuration.

Line Key  
Programmable Key  
EXP KEY

Expansion Key Expansion 1

Key	Type	Value	Label	Account	Pickup Code
Key1	Line			Account 1	
Key2	DTMF			Account 1	
Key3	Call Return			Account 1	
Key4	BLF	900		Account 1	

NOTE

## SMS

### To configure SMS via Web Interface

1. Click Function keys →EXP Key.

2. Select the desired Key and select SMS in the Type.
3. Enter the Label.
4. Click the to save the configuration.

The screenshot shows the Htek web interface with the 'Expansion Key' configuration page. The 'Type' dropdown for Key3 is set to 'SMS'. The 'Label' field for Key3 is highlighted with a red box. The 'Account' dropdown for Key3 is set to 'Account 1'. The 'Pickup Code' field for Key3 is empty. The 'Value' field for Key3 is empty. The 'Label' field for Key3 is highlighted with a red box.

Key	Type	Value	Label	Account	Pickup Code
Key1	Line			Account 1	
Key2	DTMF			Account 1	
Key3	SMS			Account 1	
Key4	BLF	900		Account 1	

## Record

With record feature, you can record calls by pressing a record key on the phone.

### To configure the record via Web Interface

1. Click Function keys → EXP Key.
2. Select the desired Key and select Record in the Type.
3. Enter the Label displayed on LCD.
4. Click the to save the configuration.

The screenshot shows the Htek web interface with the 'Expansion Key' configuration page. The 'Type' dropdown for Key3 is set to 'Record'. The 'Label' field for Key3 is highlighted with a red box. The 'Account' dropdown for Key3 is set to 'Account 1'. The 'Pickup Code' field for Key3 is empty. The 'Value' field for Key3 is empty. The 'Label' field for Key3 is highlighted with a red box.

Key	Type	Value	Label	Account	Pickup Code
Key1	Line			Account 1	
Key2	DTMF			Account 1	
Key3	Record			Account 1	
Key4	BLF	900		Account 1	

### Note:

Please contact the system administrator whether support this feature or not.

## URL Record

The phone sends HTTP URL request to trigger a recording. Contact your system administrator for the predefined URL.

### To configure the record via Web Interface

1. Click Function keys → EXP Key.
2. Select the desired Line or Line Key and select URL Record in the Type.
3. Enter the Label displayed on LCD
4. Click the  to save the configuration

Key	Type	Value	Label	Account	Pickup Code
Key1	Line			Account 1	
Key2	DTMF			Account 1	
Key3	URL Reco			Account 1	
Key4	BLF	900		Account 1	

## Paging

With this feature, you can call a phone or a group directly.

### To configure the Paging via Web interface

1. Click Function keys → EXP Key.
2. Select the desired Key and select Paging in the Type.
3. Enter the Paging codes followed by phone number or group number
4. Enter the Label displayed on LCD.
5. Click the  to save the configuration.



[logout](#)  
 Home | Account | Network | **Function Keys** | Setting | Directory | Management

Line Key  
 Programmable Key  
 EXP KEY

Expansion Key Expansion 1

Key	Type	Value	Label	Account	Pickup Code
Key1	Line			Account 1	
Key2	DTMF	*6		Account 1	
Key3	Transfer	906		Account 1	
Key4	Paging	632		Account 1	
Key5	N/A			Account 1	

NOTE

## Public Hold

The key can be configured as a public hold key. During a conversation, all members belonging to that particular SLA group can use this key to hold or resume a call.

### To configure public hold via Web Interface

1. Click Function keys → EXP Key.
2. Select the desired Key and select public hold in the Type.
3. Enter the Label displayed on LCD.
4. Click the  to save the configuration.

[logout](#)  
 Home | Account | Network | **Function Keys** | Setting | Directory | Management

Line Key  
 Programmable Key  
 EXP KEY

Expansion Key Expansion 1

Key	Type	Value	Label	Account	Pickup Code
Key1	Line			Account 1	
Key2	DTMF			Account 1	
Key3	Public Hol			Account 1	
Key4	BLF	900		Account 1	
Key5	N/A			Account 1	

NOTE

## Private Hold

The key can be configured as a private hold key. During a conversation, all members belonging to that particular SLA group can use this key to hold the call, but only the initiator can resume the call.

### To configure private hold via Web Interface

1. Click Function keys →EXP Key.
2. Select the desired Key and select public hold in the Type.
3. Enter the Label displayed on LCD.
4. Click the  to save the configuration.

Expansion Key

Key	Type	Value	Label	Account	Pickup Code
Key1	Line			Account 1	
Key2	DTMF			Account 1	
Key3	Private Ho			Account 1	
Key4	BLF	900		Account 1	

NOTE

## Hot Desking

To configure the hot desking via web interface:

1. Click Function keys →EXP Key.
2. Select the desired Key and select hot desking in the Type.
3. Enter the Label displayed on LCD.
4. Select the Account.
5. Click the  to save the configuration.

Expansion Key

Key	Type	Value	Label	Account	Pickup Code
Key1	Line			Account 1	
Key2	DTMF			Account 1	
Key3	Hot Deskii			Account 1	
Key4	BLF	900		Account 1	

NOTE

## ACD

To configure the ACD via web interface:

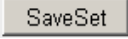
1. Click Function keys →EXP Key.
2. Select the desired Key and select ACD in the Type.
3. Enter the Label displayed on LCD.
4. Select the Account.
5. Click the  to save the configuration.

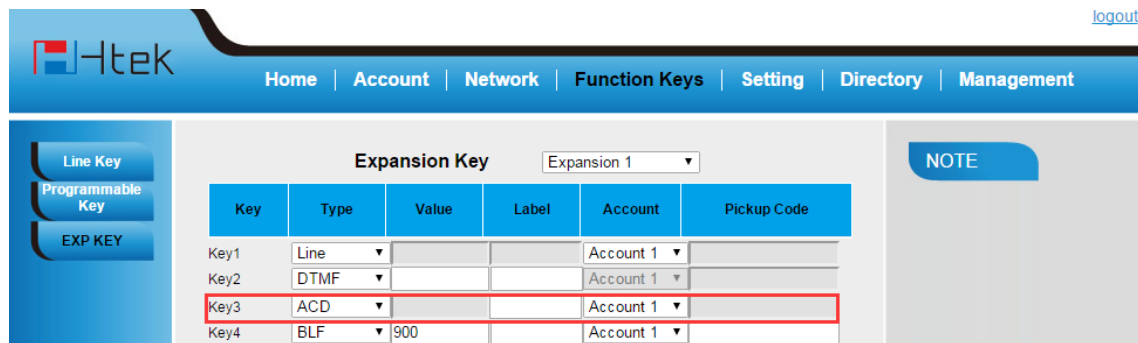

Key	Type	Value	Label	Account	Pickup Code
Key1	Line			Account 1	
Key2	DTMF			Account 1	
Key3	ACD			Account 1	
Key4	BLF	900		Account 1	

## Zero Touch

To configure the Zero Touch via web interface:

1. Click Function keys →EXP Key.
2. Select the desired Key and select **Zero Touch** in the Type.
3. Enter the Label displayed on LCD.
4. Select the Account.
5. Click the  to save the configuration.

[logout](#)

Htek

[Home](#) | [Account](#) | [Network](#) | [Function Keys](#) | [Setting](#) | [Directory](#) | [Management](#)

Line Key

Programmable Key

EXP KEY

**Expansion Key**    Expansion 1 ▾

Key	Type	Value	Label	Account	Pickup Code
Key1	Line ▾			Account 1 ▾	
Key2	DTMF ▾			Account 1 ▾	
Key3	Zero Toucl ▾			Account 1 ▾	
Key4	BLF ▾	900		Account 1 ▾	

NOTE

## URL

**To configure the URL via web interface:**

1. Click Function keys →EXP Key.
2. Select the desired Key and select **URL** in the Type.
3. Enter the Label displayed on LCD.
4. Click the SaveSet to save the configuration.

[logout](#)

Htek

[Home](#) | [Account](#) | [Network](#) | [Function Keys](#) | [Setting](#) | [Directory](#) | [Management](#)

Line Key

Programmable Key

EXP KEY

**Expansion Key**    Expansion 1 ▾

Key	Type	Value	Label	Account	Pickup Code
Key1	Line ▾			Account 1 ▾	
Key2	DTMF ▾			Account 1 ▾	
Key3	URL ▾			Account 1 ▾	
Key4	BLF ▾	900		Account 1 ▾	

NOTE

## MultiCast Paging

**To configure the MultiCast Paging via web interface:**

1. Click Function keys →EXP Key.
2. Select the desired Key and select **MultiCast Paging** in the Type.
3. Enter the Label displayed on LCD.

4. Click the  to save the configuration.

Key	Type	Value	Label	Account	Pickup Code
Key1	Line			Account 1	
Key2	DTMF			Account 1	
Key3	MultiCast			Account 1	
Key4	BLF	900		Account 1	

## Upgrade

Hanlong UC46 Expansion Module upgrades in an indirect mode, first, the IP Phone that connects with expansion module upgrades the expansion module FW, then the expansion module upgrades via getting fw46.rom file from the phone. For detailed schedule, please see below instruction.

### IP Phone upgrades the expansion module FW

Before upgrade the expansion module, please make sure your IP Phone could upgrade

the expansion module FW (we suggest your IP Phone's FW version running later **1.0.3.98 FW**). The instructions for upgrade the expansion module FW on your phone are as follows:

(1) First enable “**Upgrade EXP Firmware**” option from Management->Auto provision->Upgrade EXP Firmware

Upgrade EXP Firmware  No  Yes

HTTP/FTP/HTTPS UserName

HTTP/FTP/HTTPS Password

Firmware/Config File Prefix

Firmware/Config File Postfix

- If set this option to Yes, the IP Phone will get fw46.rom file after rebooting IP Phone
- If set this option to NO, the IP Phone will not get fw46.rom file.

(2) Put the fw46.rom into the upgrade server path. You can upgrade by TFTP/HTTP/HTTPS/FTP.

(3) Set the server path at Webpage-Management-Auto Provision-Firmware Server Path.

(4) After you upgrade by TFTP/HTTP/HTTPS/FTP, please log on Webpage-Home-Expansion Module Version to check whether the expansion module FW has been upgraded successfully. See below picture

● **Expansion Module Version** ?

Version on phone	BOOT--(N/A)
UC40's version	IMG--1.0.3.80(2015-06-24 15:49:00)
UC46's version	VOIP--1.0.3.98(2016-03-28 19:05:00)
	ROM--2.0.3.98(2016-07-08 18:13:00)

## Expansion module gets the fw46.rom from IP Phone

(1) Before connect the expansion module, please log on Webpage-Network-Basic-PC Port, choose to Connect to Expansion Module, and then click SaveSet. See below picture. Or Menu->Setting->Advanced Setting ->Network->PC port ->Connect to module on Phone LCD.

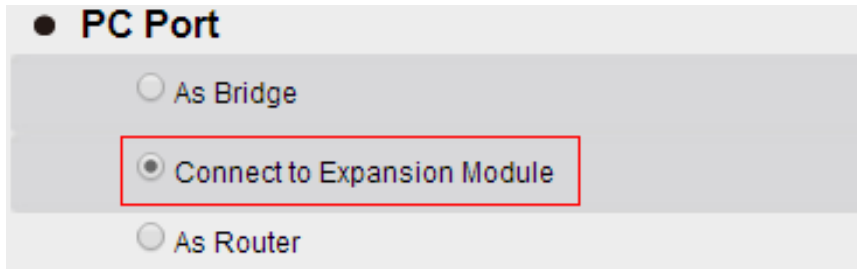

- (2) Connect Phone's PC port and UC46's Uplink port with Ethernet cable
- (3) Power up UC46 expansion module, then UC46 would automatically get the expansion module FW from the phone, and automatically restart to finish the upgrade.
- (4) After upgrade, please check whether the FW show on the phone status is same as the FW show on the Webpage, If it is same, it means that the FW has been upgraded successfully. Below picture for reference.

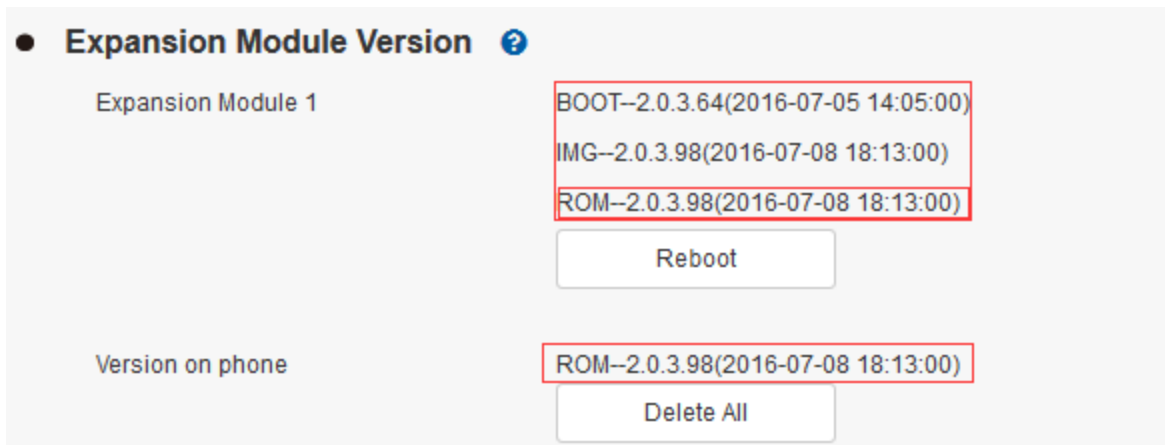

- (5) If expansion module FW did not upgrade successfully, please restart the expansion module to upgrade the FW again.

**Notes:**

1. Only Color models, UC924/926 could connect to UC46 expansion module.
2. Please connect one expansion module with one phone for upgrade.
3. Please do not power off the phone during the upgrade. Otherwise it may cause damage to the phone and expansion module.